



Mutual Life Insurance 1884. Under-window radiators with fresh air inlet ventilation and mechanical exhaust.

HVAC IN HISTORIC BUILDINGS OF USA PART ONE NEW YORK CITY

BRIAN ROBERTS

MANHATTAN LIFE INSURANCE



Under-window radiators, sash inlet ventilators and mechanical exhaust 1894.
Note external window blinds.



YOU ARE CORDIALLY INVITED TO A
PRIVATE SHOWING OF NEW YORK'S
FINEST PRE-WAR BUILDINGS.

The Heritage Group has recorded details of the history and HVAC engineering services in a variety of early New York buildings, some of which are shown in this booklet.

CONTENTS: FEATURED BUILDINGS

COVER: Astor Hotel: *front*, Manhattan Life Insurance: *inside front*,
Ansonia Hotel: *inside back*, Carnegie Hall: *back*.

Mutual Life: 1,16-18,44, Manhattan Life: 2,19, Skyscraper: 3, Opera House: 4-5,
Carnegie Hall: 6-9, Music Hall: 10-11, Brooklyn Academy: 12-15, Stock Exchange: 20-23,
Woolworth: 24-25, Wanamaker: 26-29, Ellis Island: 30-31, Cooper Union: 32-33,
Astor Hotel: 34-37, Ansonia Hotel: 38-39, Knickerbocker Hotel: 40-41, Carnegie Home: 42-43.

METROPOLITAN OPERA HOUSE

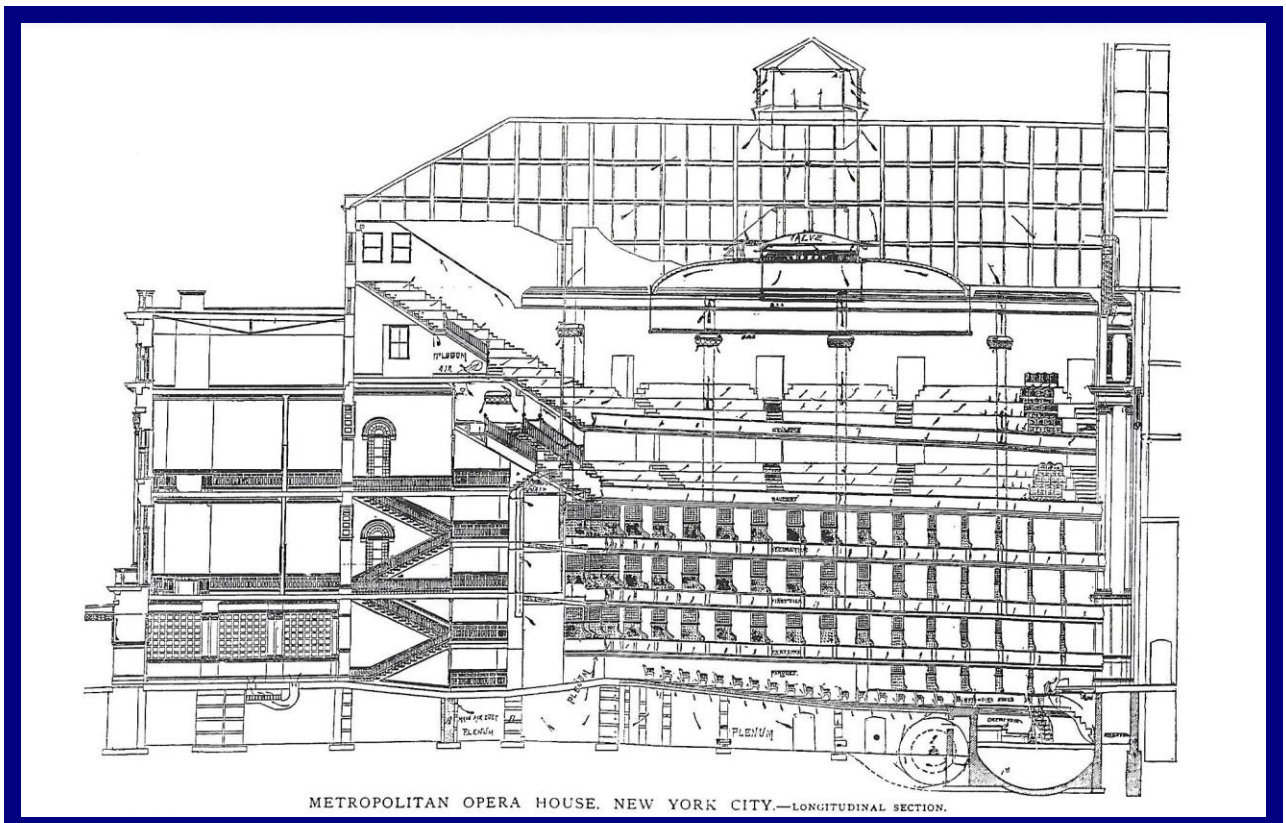

Drawing of ventilation system 1883.

METROPOLITAN OPERA HOUSE

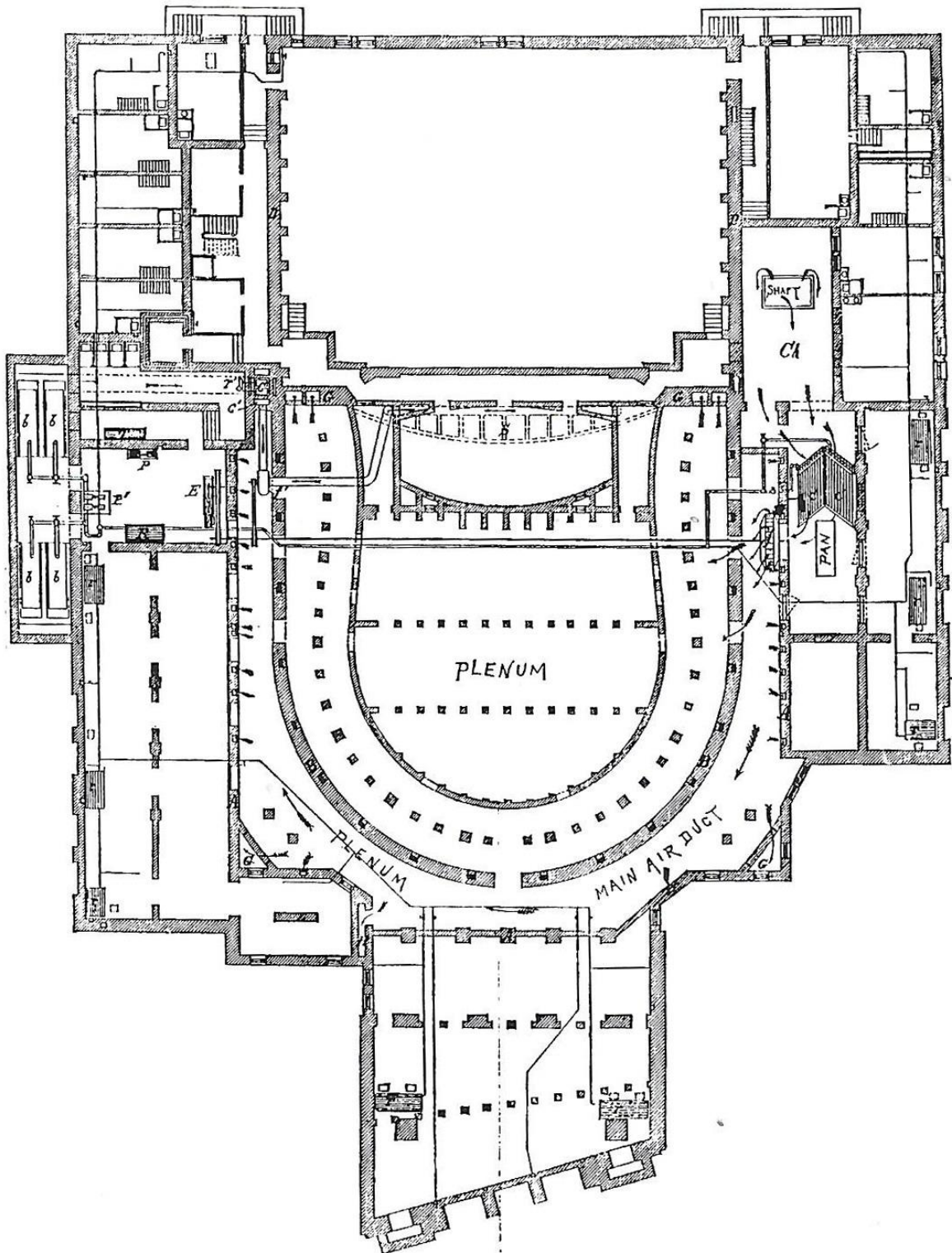

METROPOLITAN OPERA HOUSE, NEW YORK CITY, GROUND PLAN.

CARNEGIE HALL

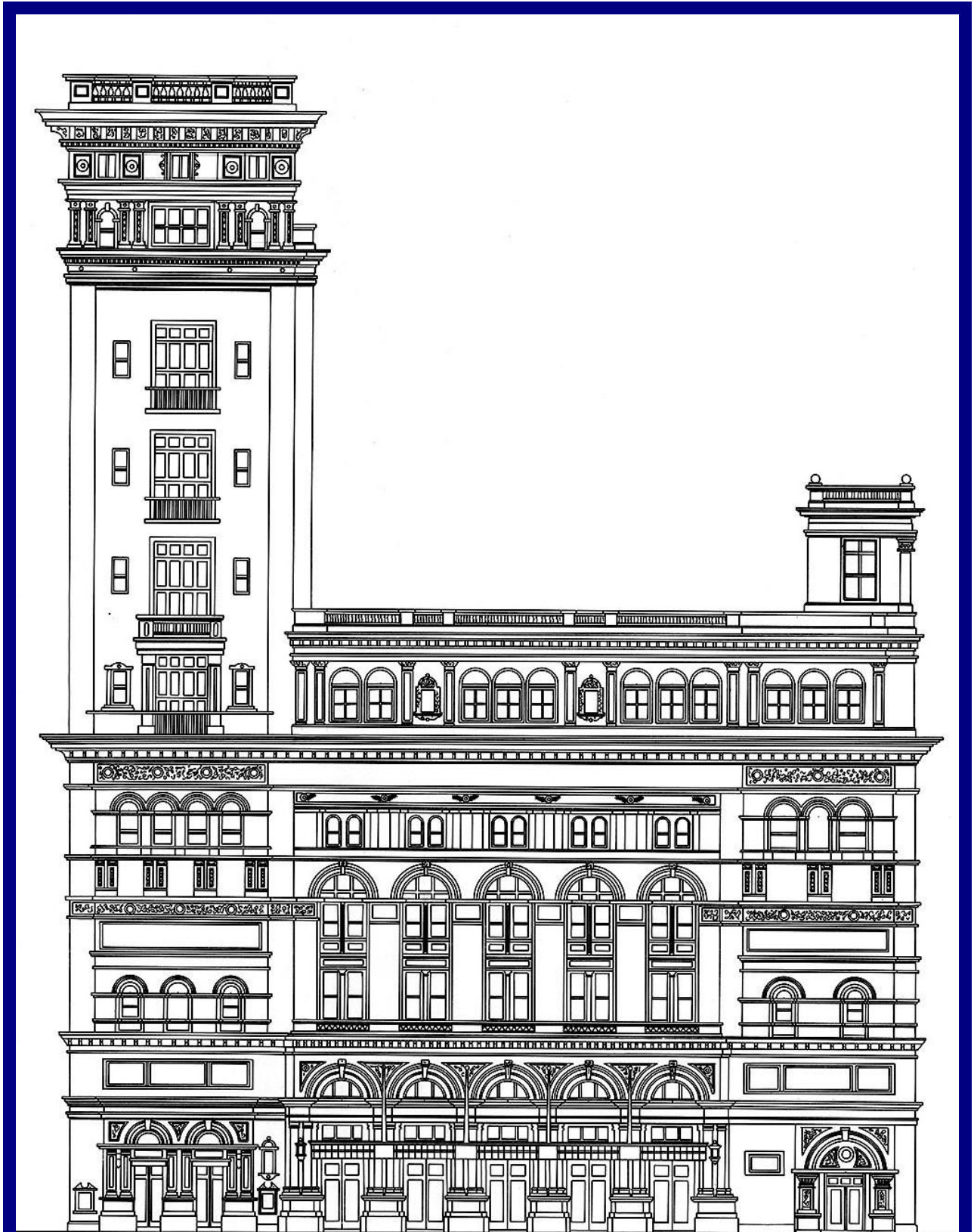

CARNEGIE HALL - NEW YORK

CARNEGIE HALL

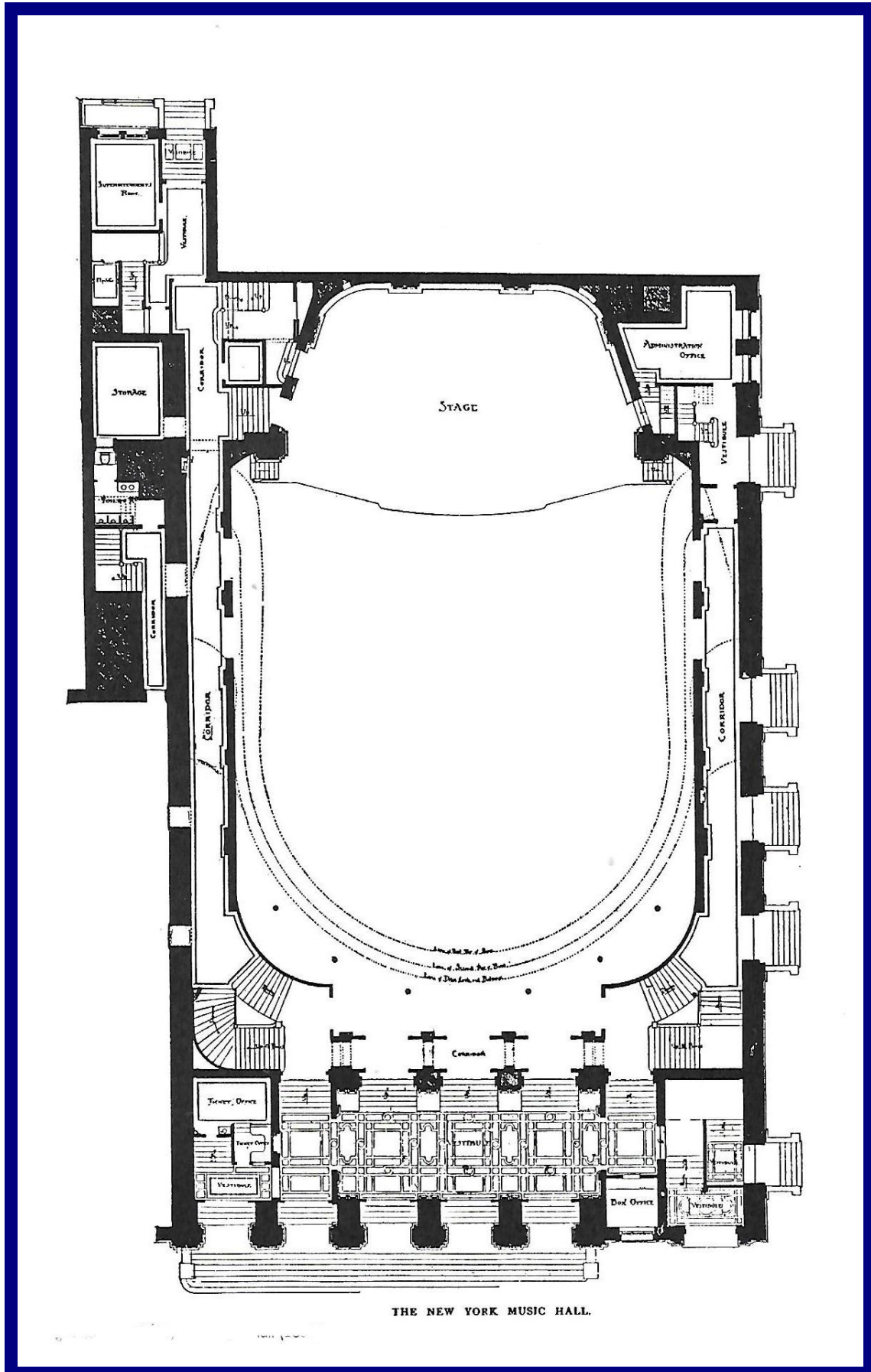

Plan of 1891.

NEW YORK MUSIC HALL

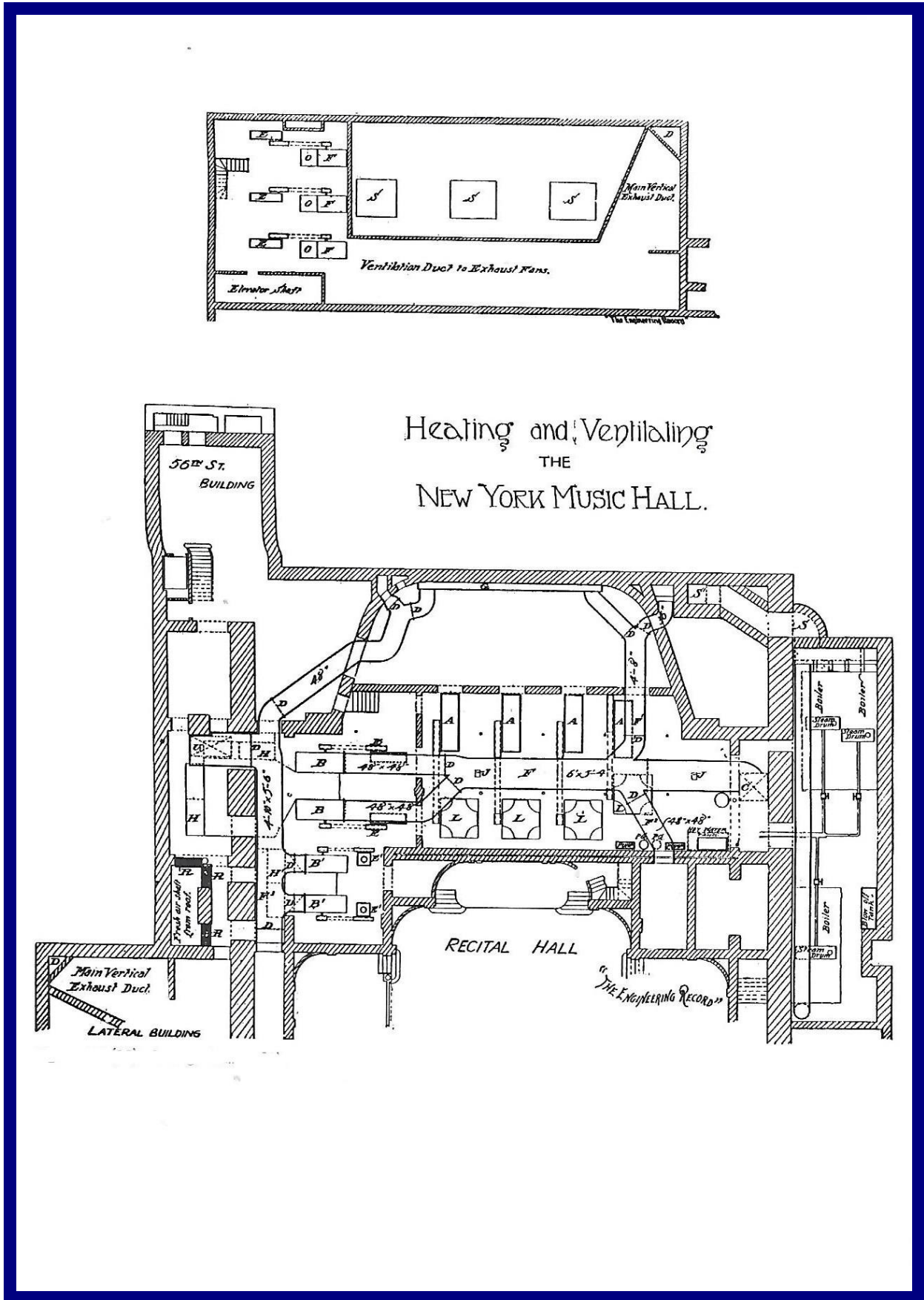

The Music Hall was one of three Halls within Carnegie Hall. Drawing of 1891.

NEW YORK MUSIC HALL

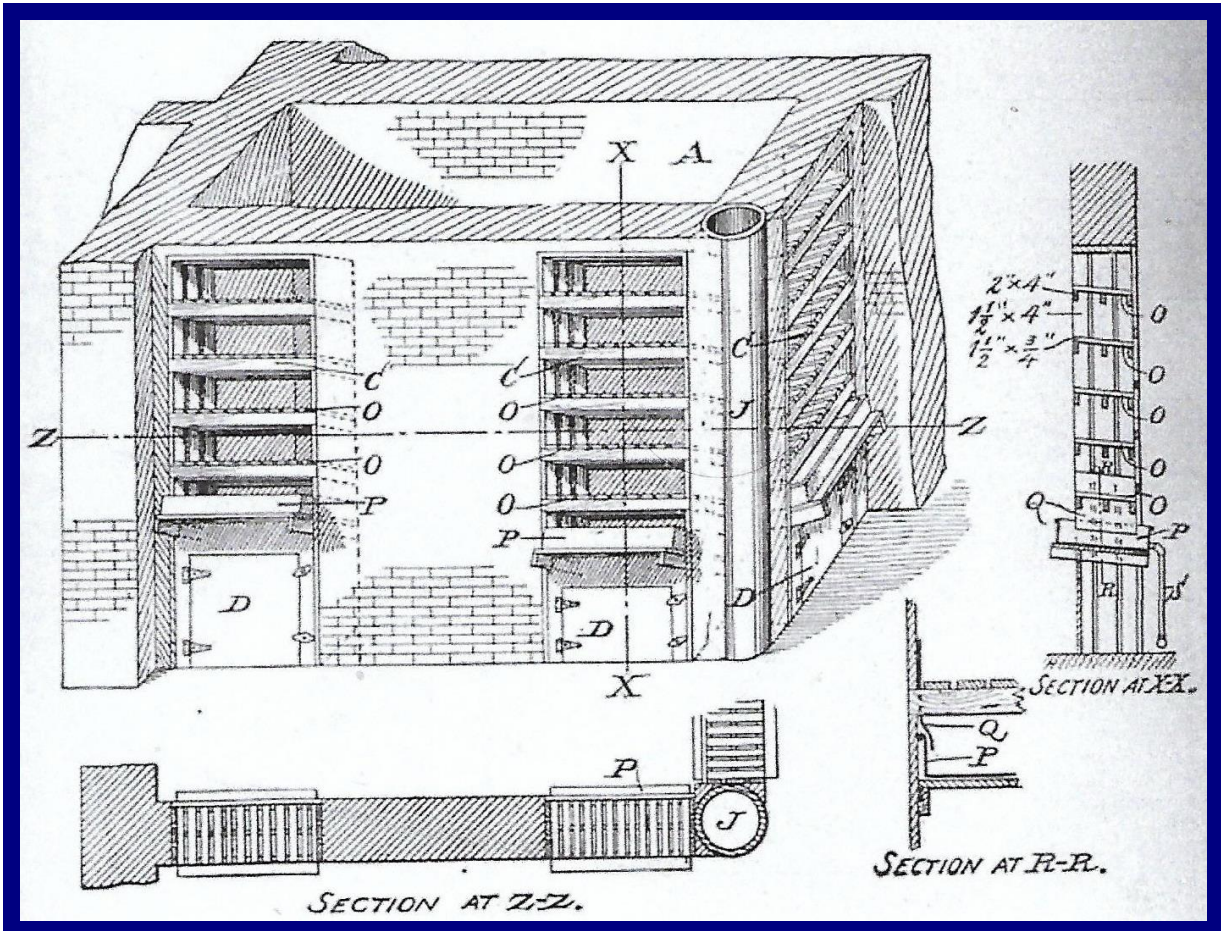
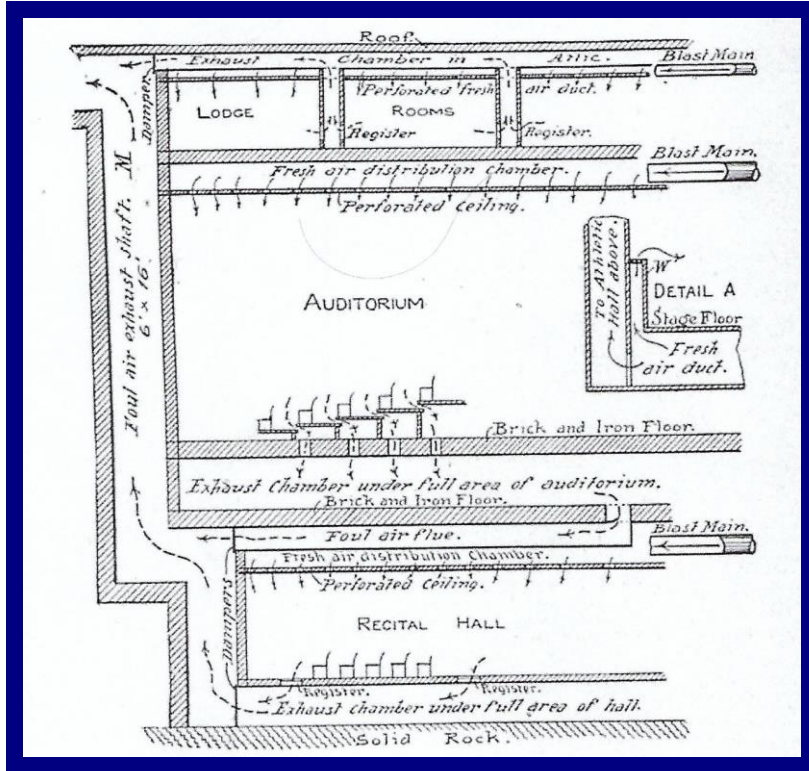

Air cooling ventilation ducts (top) and ice plant storage chamber (bottom) 1891.

NEW YORK MUSIC HALL

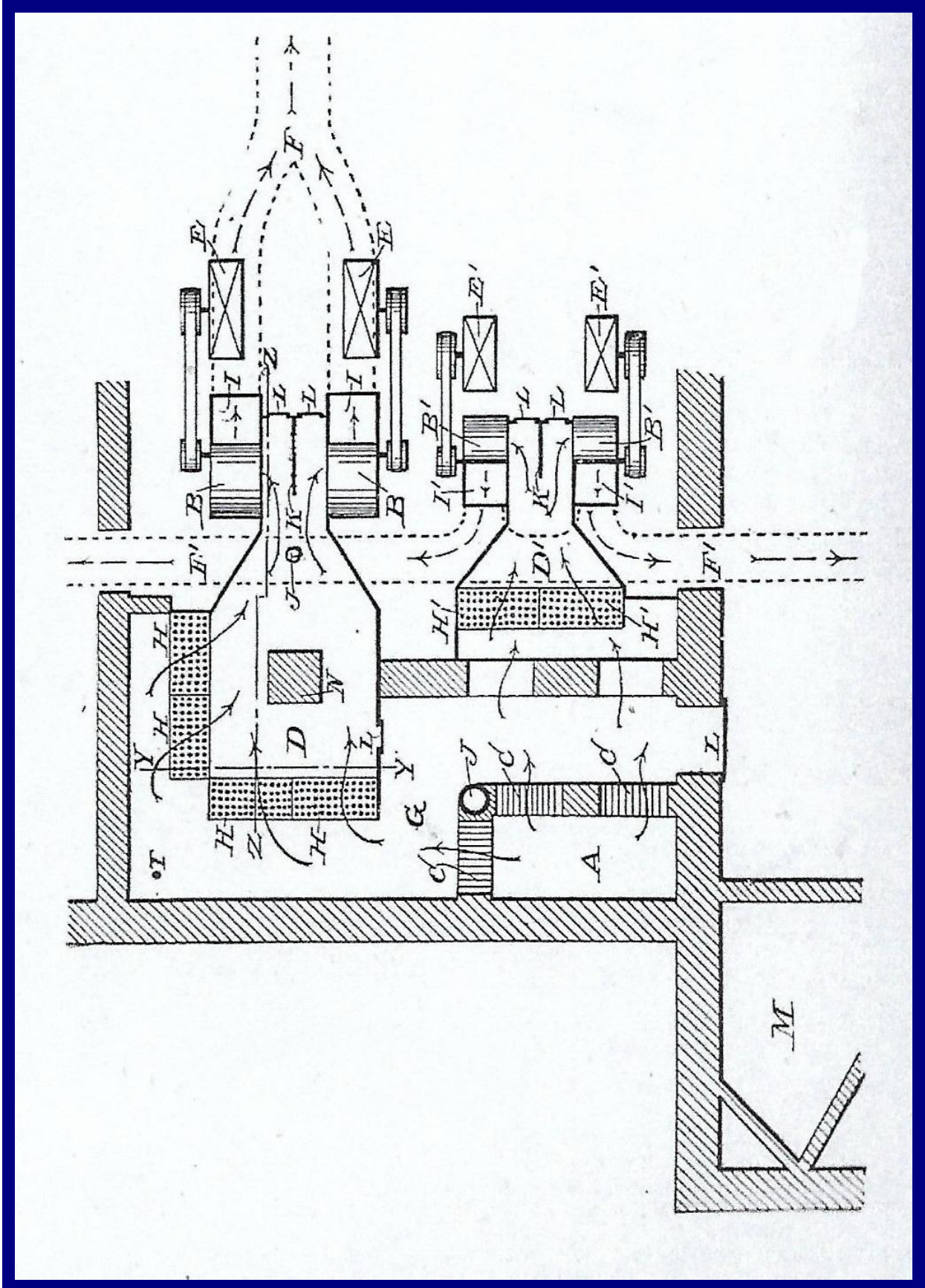

Air Cooling Ventilation Fans, 1891.

NEW YORK MUSIC HALL

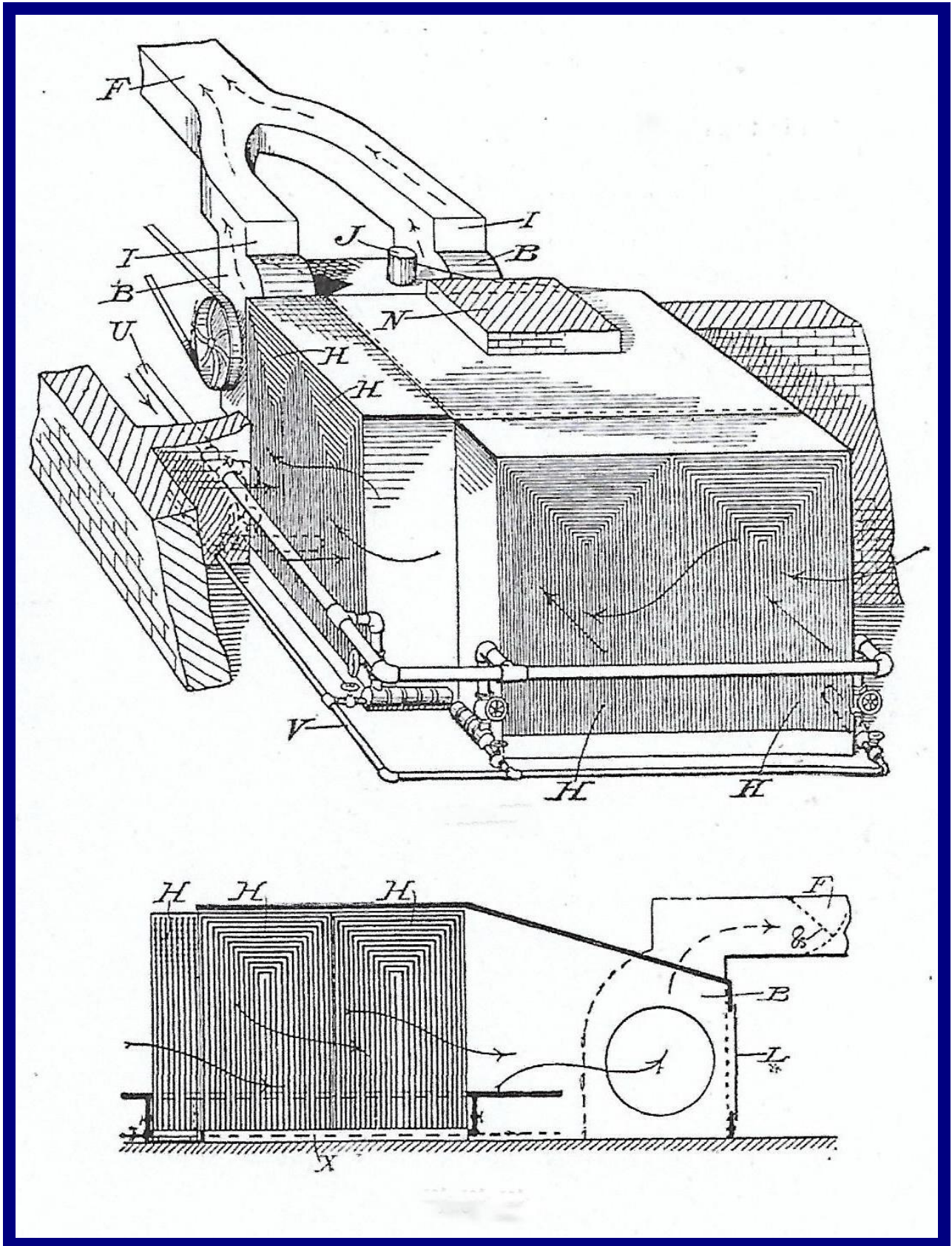

Fan Chamber 1891.

BROOKLYN ACADEMY OF MUSIC

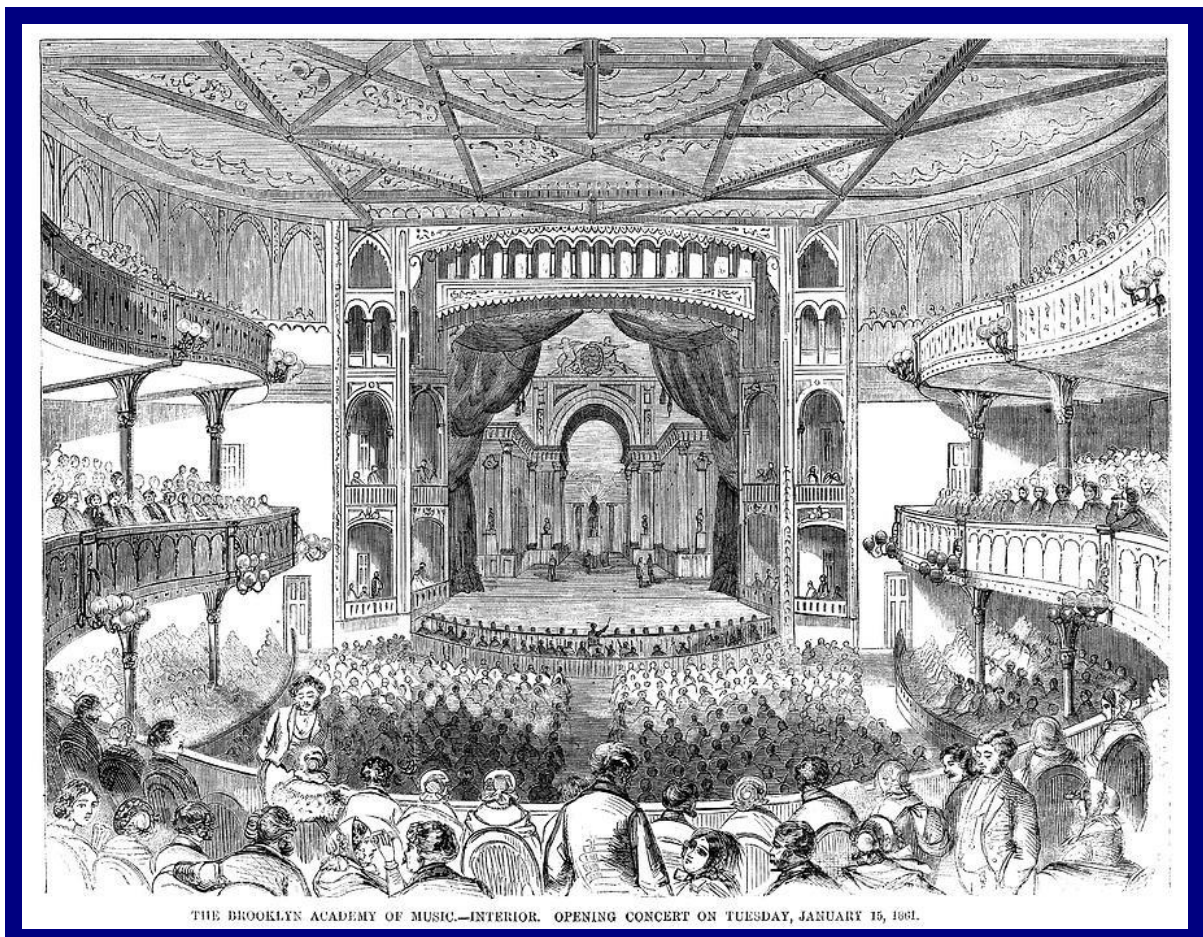

Opening Concert, January 1861.

BROOKLYN ACADEMY OF MUSIC

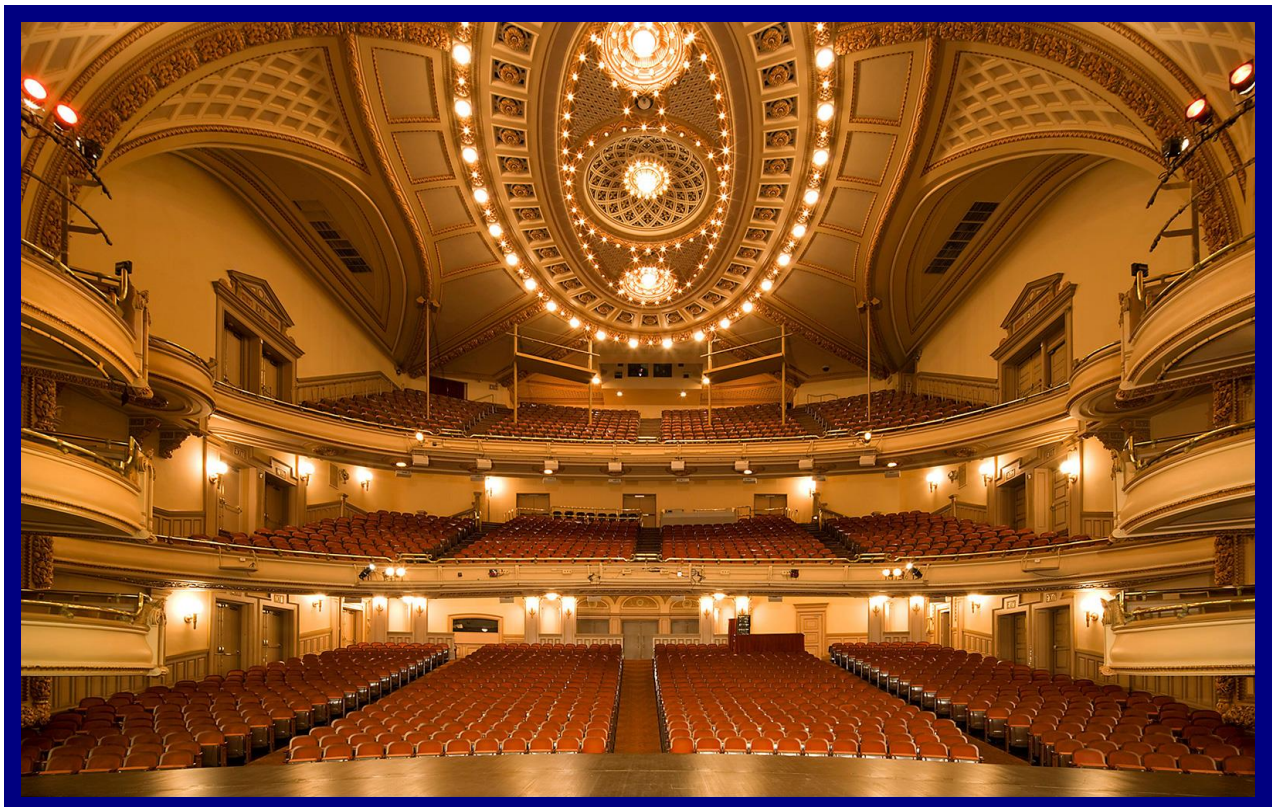

BROOKLYN ACADEMY OF MUSIC

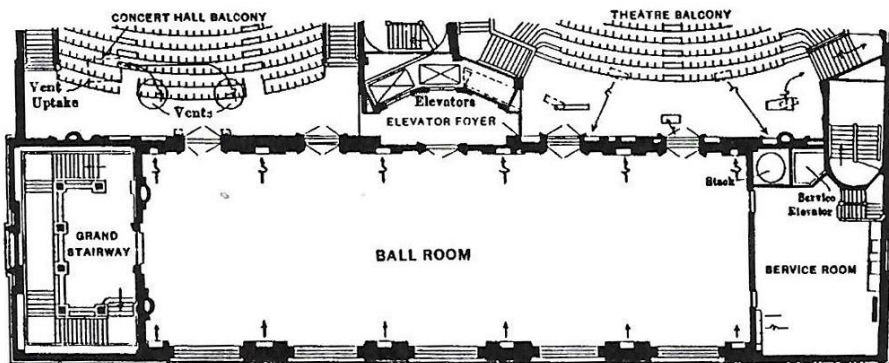
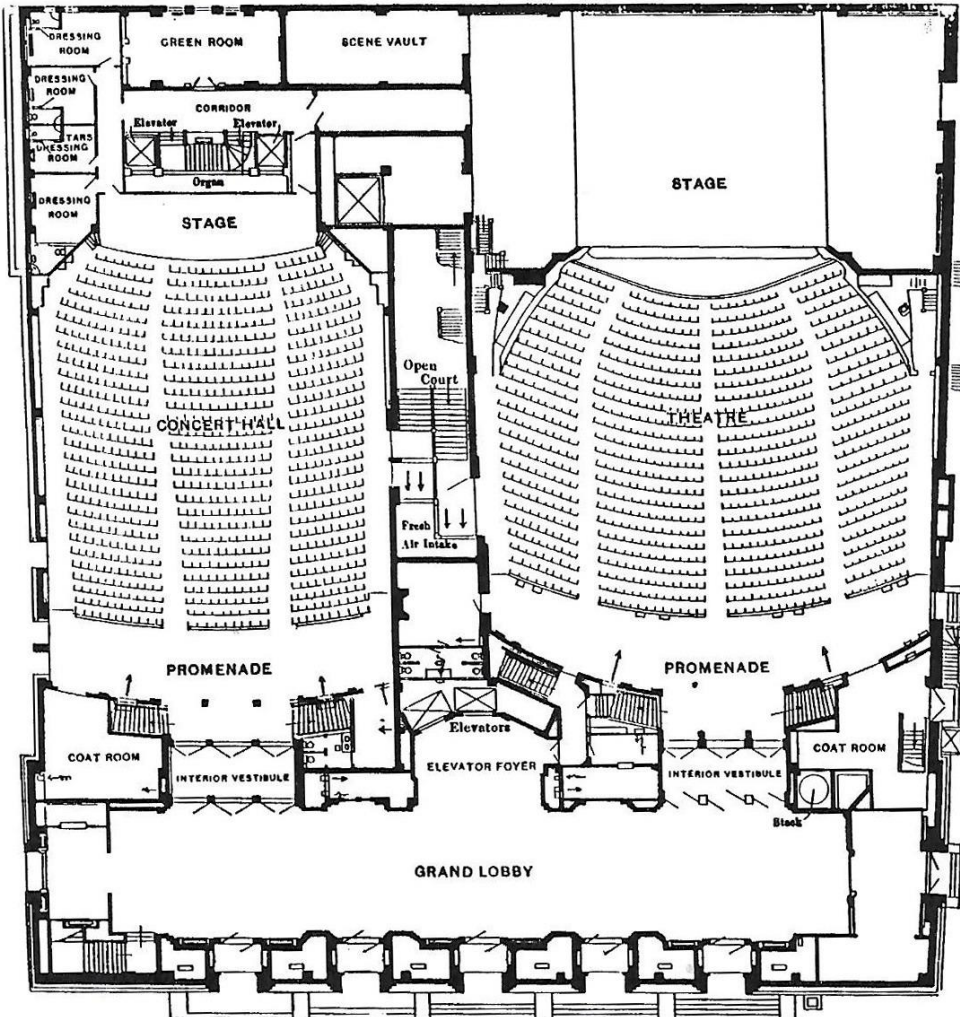

PART PLAN AT BALCONY LEVEL

Engineering Record

Ground Floor Plan of the Brooklyn Academy of Music and Plan of Ball Room.

BROOKLYN ACADEMY OF MUSIC

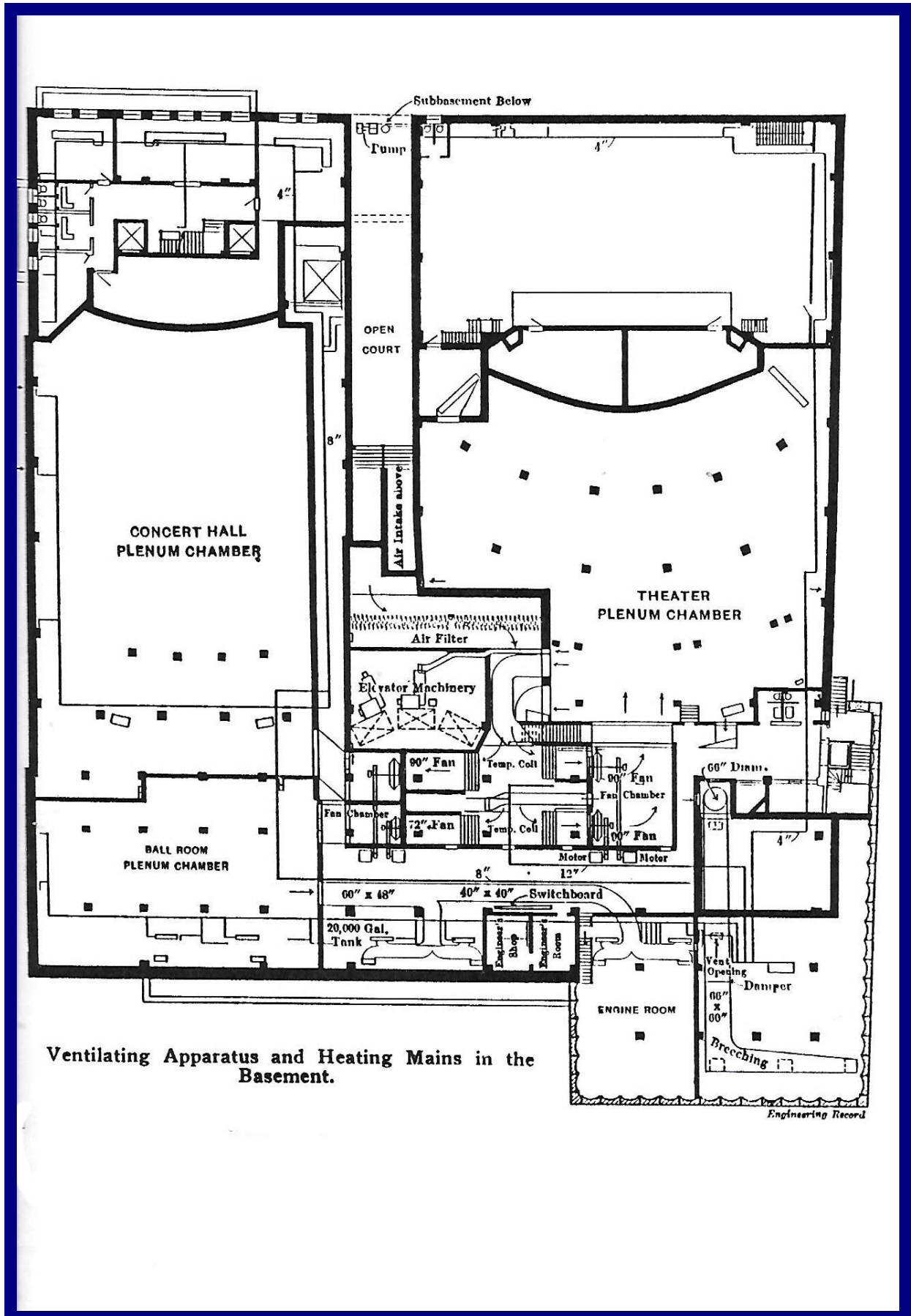

Ventilating Apparatus and Heating Mains in the Basement.

MUTUAL LIFE INSURANCE



Original building 1873, shown with 3 floors added 1891. 10 floors 176 ft.
Also known as Victory House.

MUTUAL LIFE INSURANCE

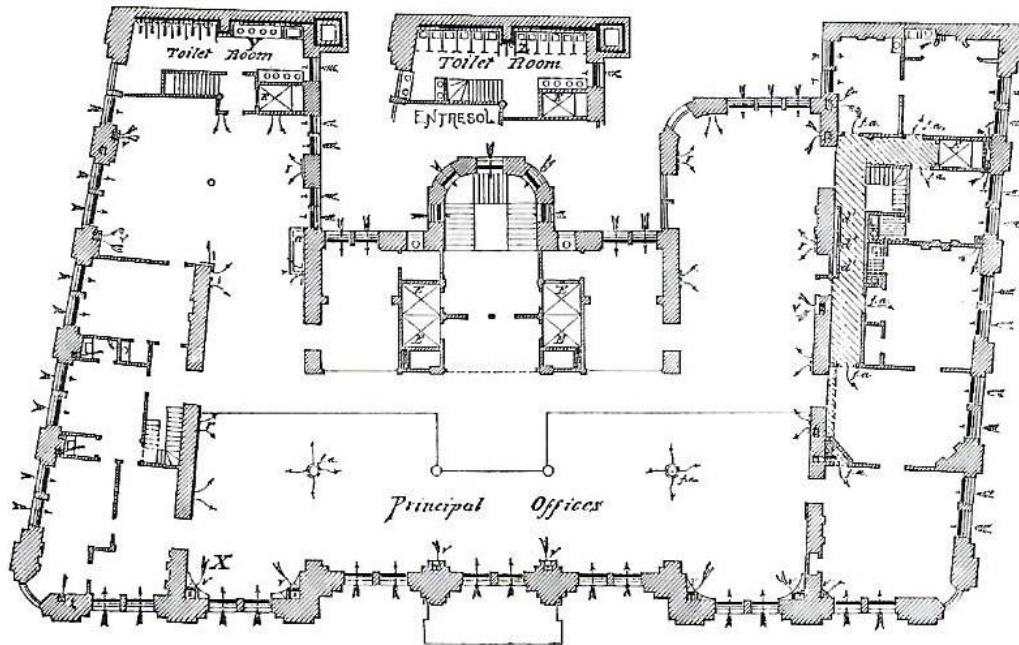

SECOND STORY PLAN

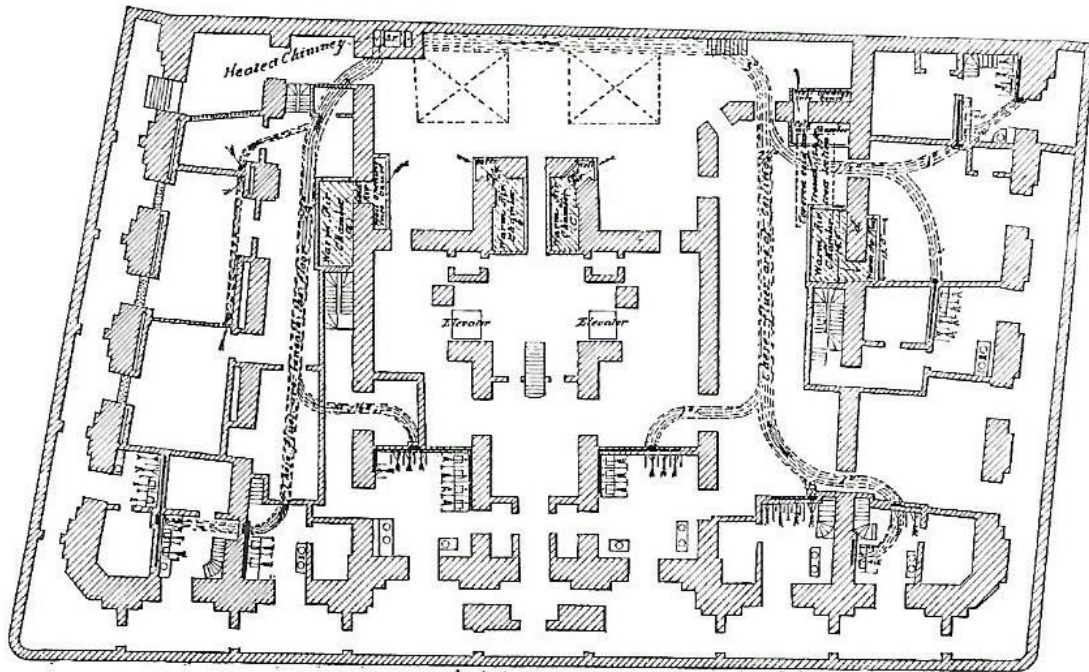

CELLAR PLAN

MUTUAL LIFE INSURANCE COMPANY'S BUILDING, NEW YORK CITY.—PLANS ILLUSTRATING THE VENTILATION.

MUTUAL LIFE INSURANCE

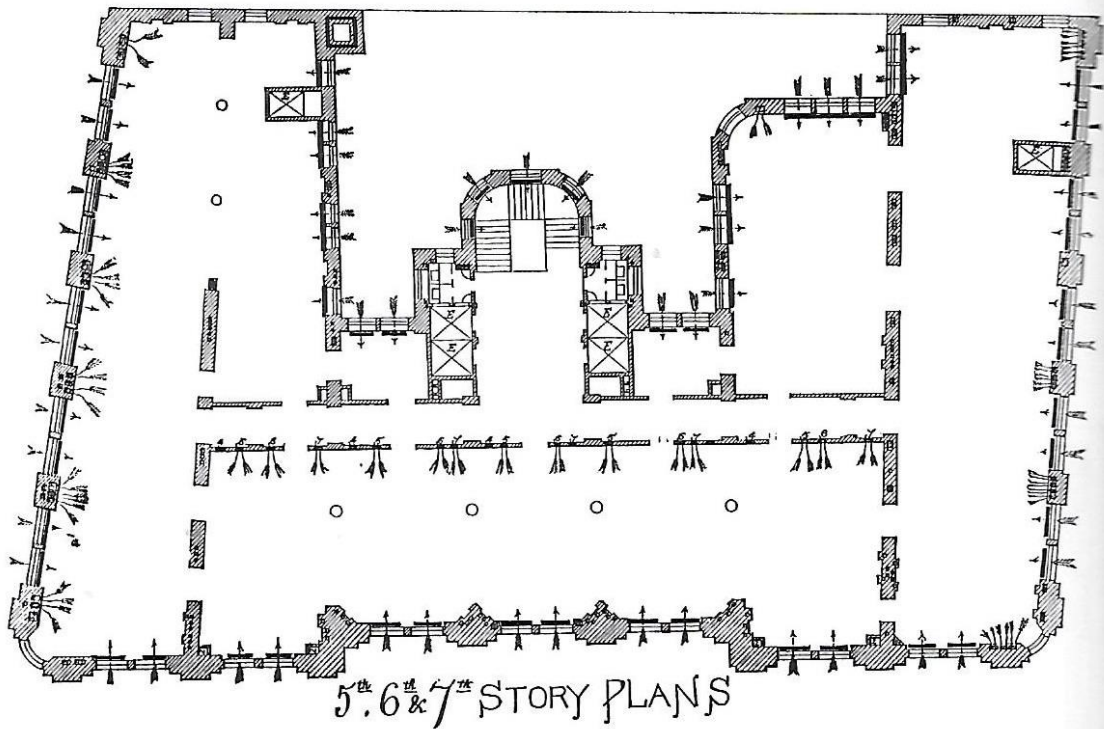
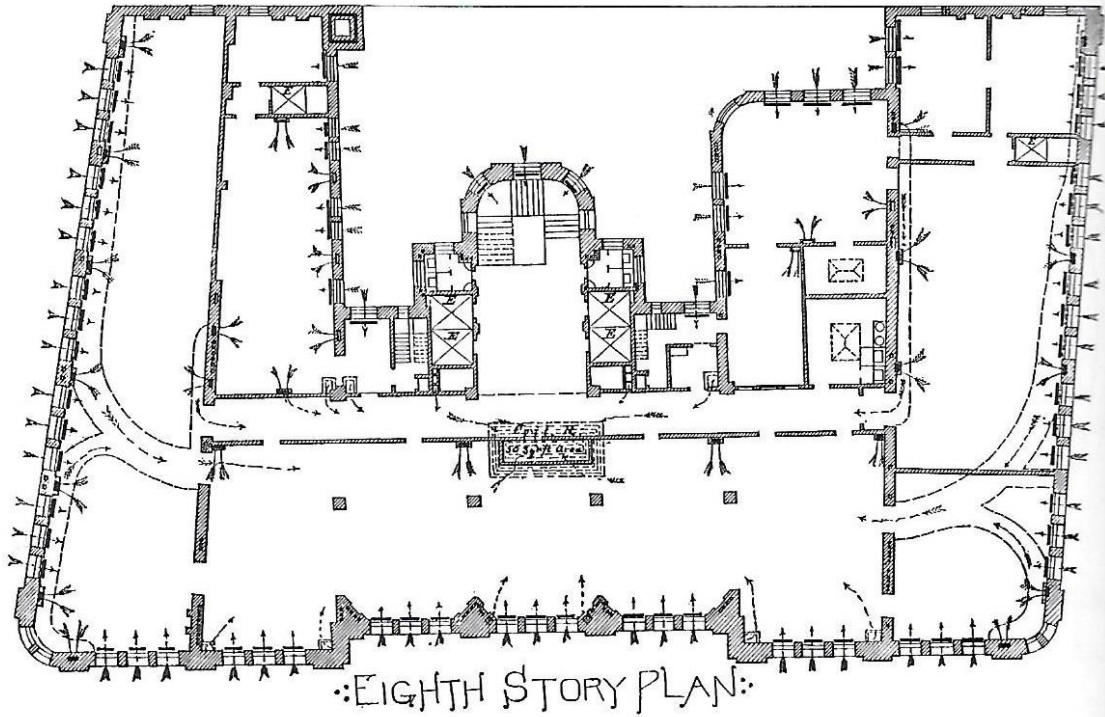

MUTUAL LIFE INSURANCE COMPANY'S BUILDING, NEW YORK CITY.—PLANS ILLUSTRATING THE VENTILATION

MANHATTAN LIFE INSURANCE

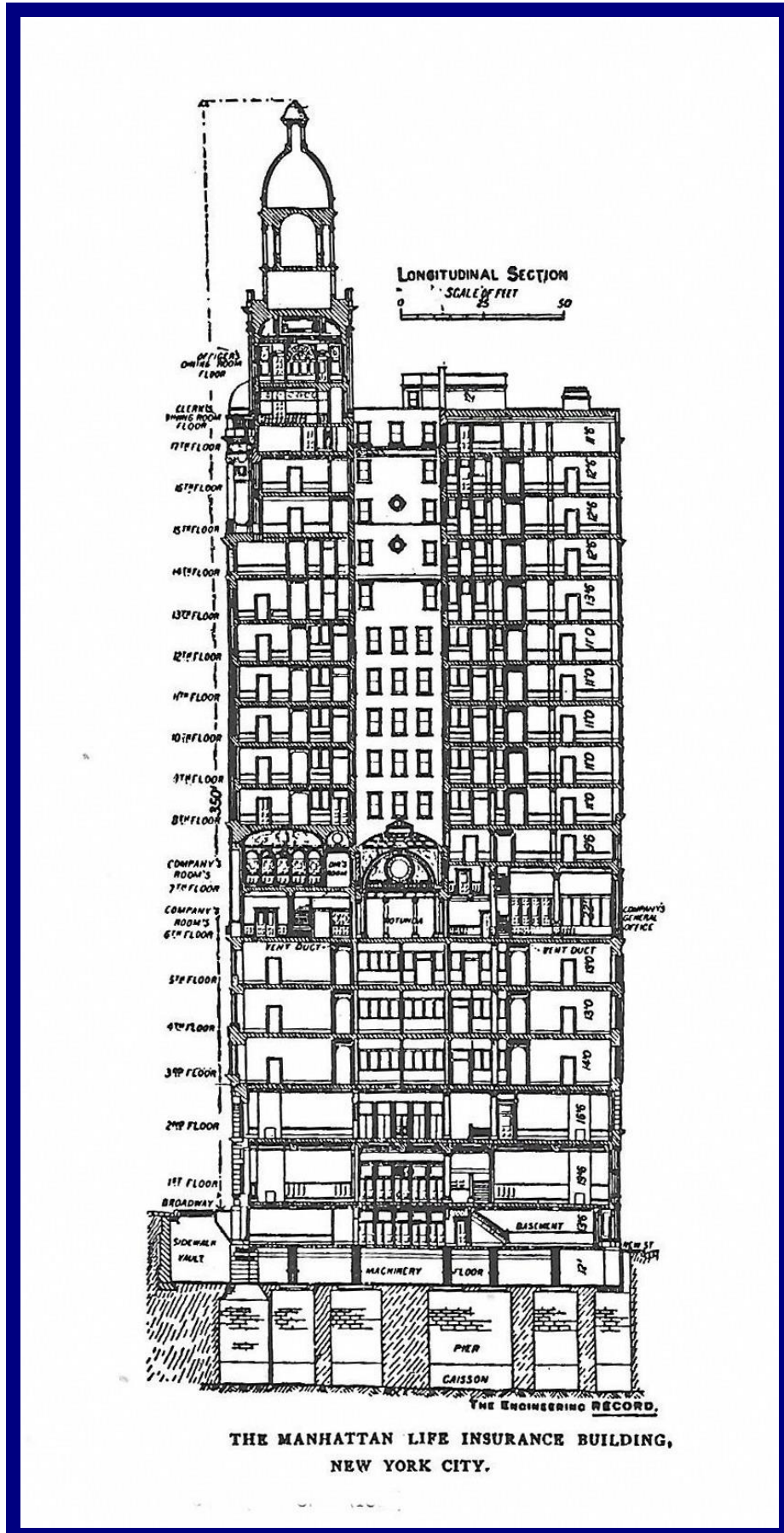

NEW YORK STOCK EXCHANGE



NEW YORK STOCK EXCHANGE

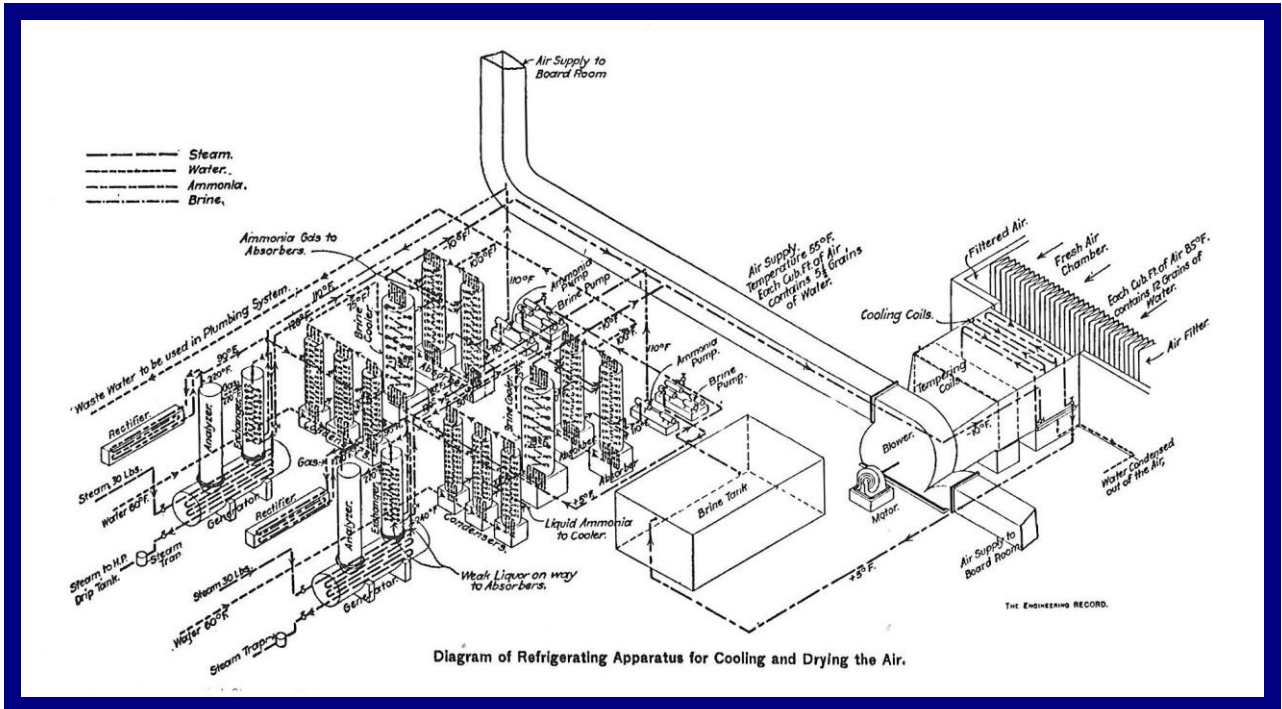

Air conditioning plant with ammonia absorption refrigeration 3 x 150 TR (450 TR total), 1905.

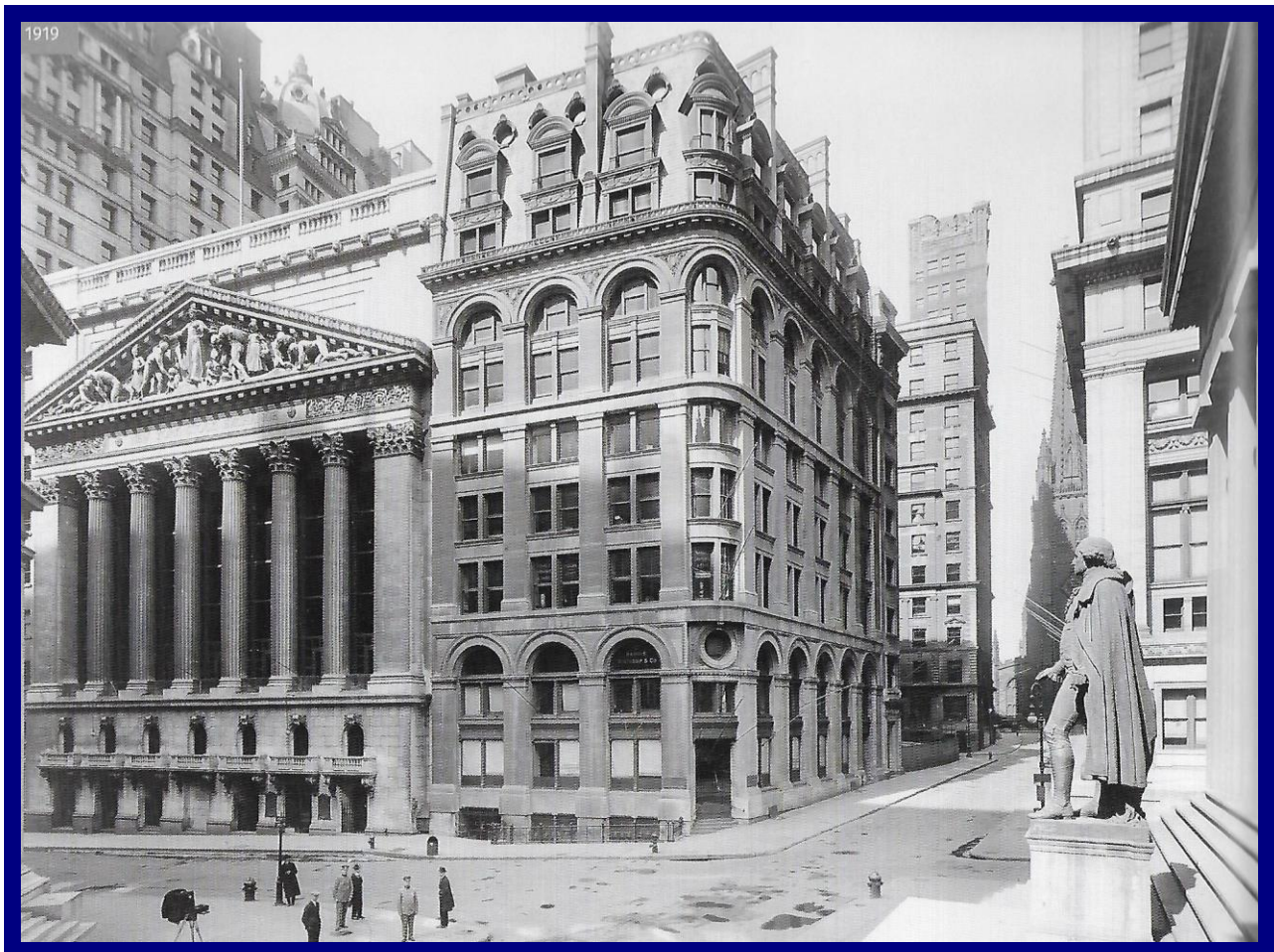

NEW YORK STOCK EXCHANGE

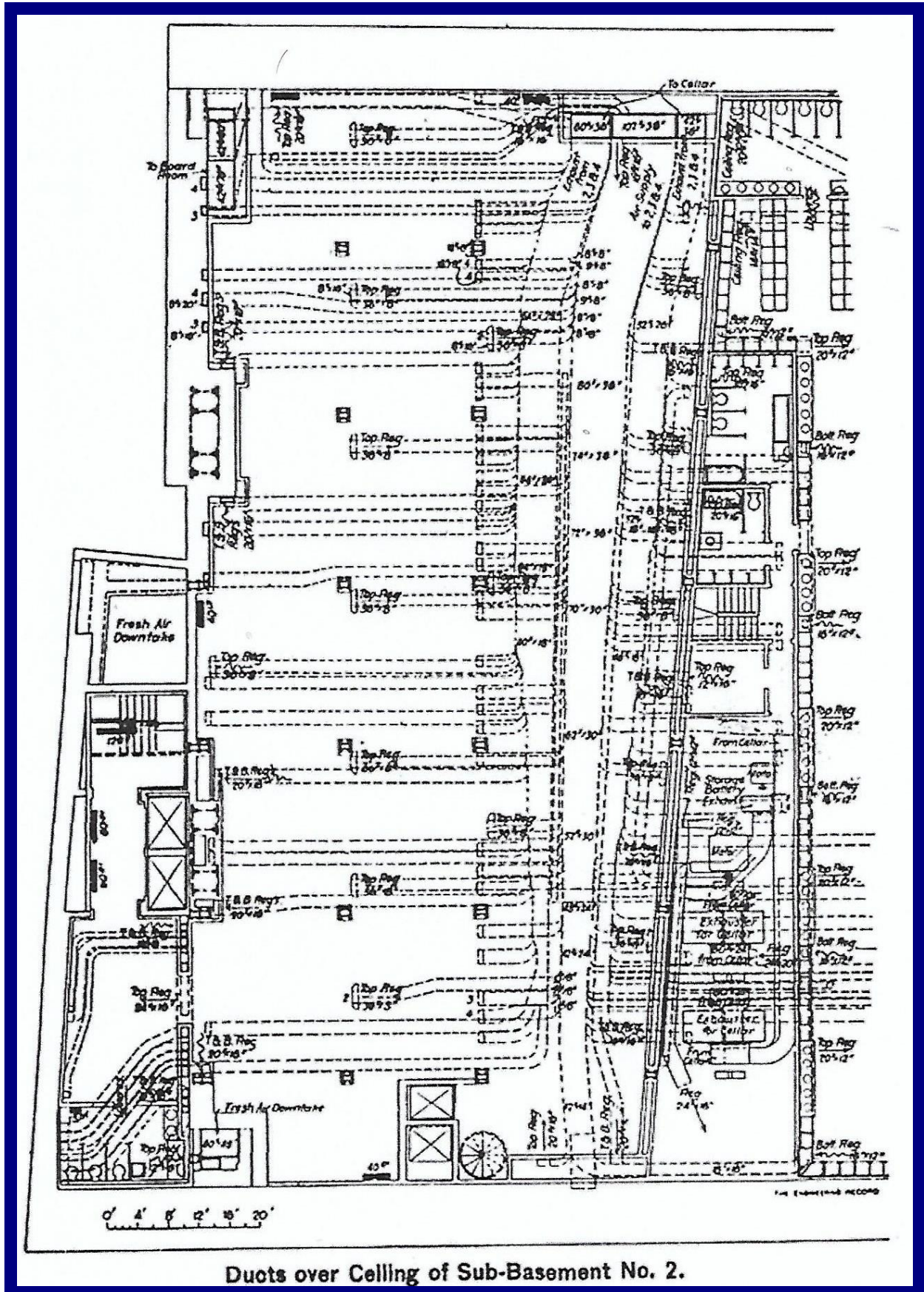

NEW YORK STOCK EXCHANGE

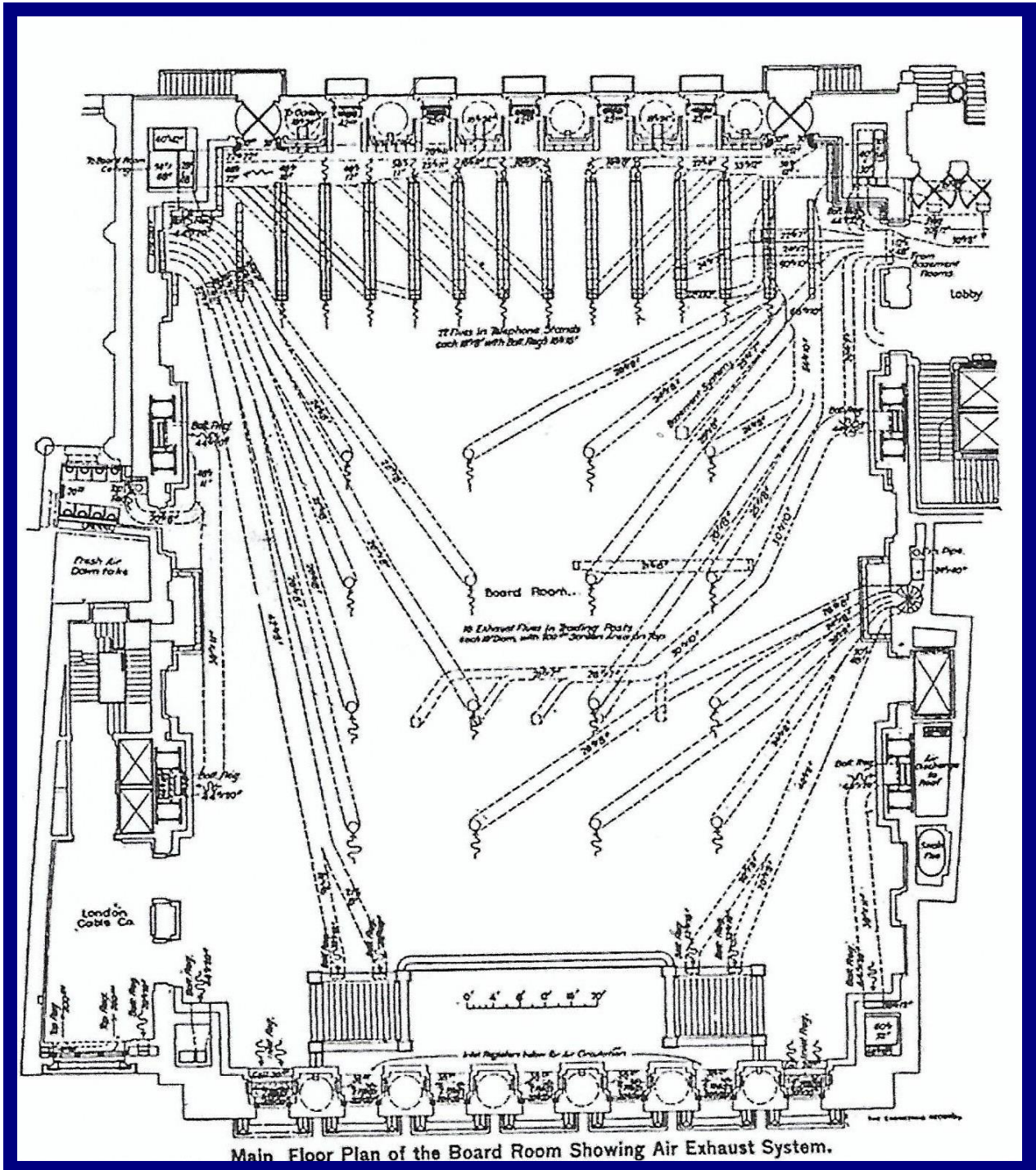

Plan of 1905.

WOOLWORTH BUILDING



792 ft, 57 floors, tallest building in world 1913-30. Provided with Dunham Vacuum Steam Heating. Mechanical Ventilation up to 46th floor. Details of HVAC, Plumbing, Elevators, Electric Power & Lighting, Central Vacuum Cleaning, are in "Master Builders," pp.45-69.

WOOLWORTH BUILDING NEW YORK

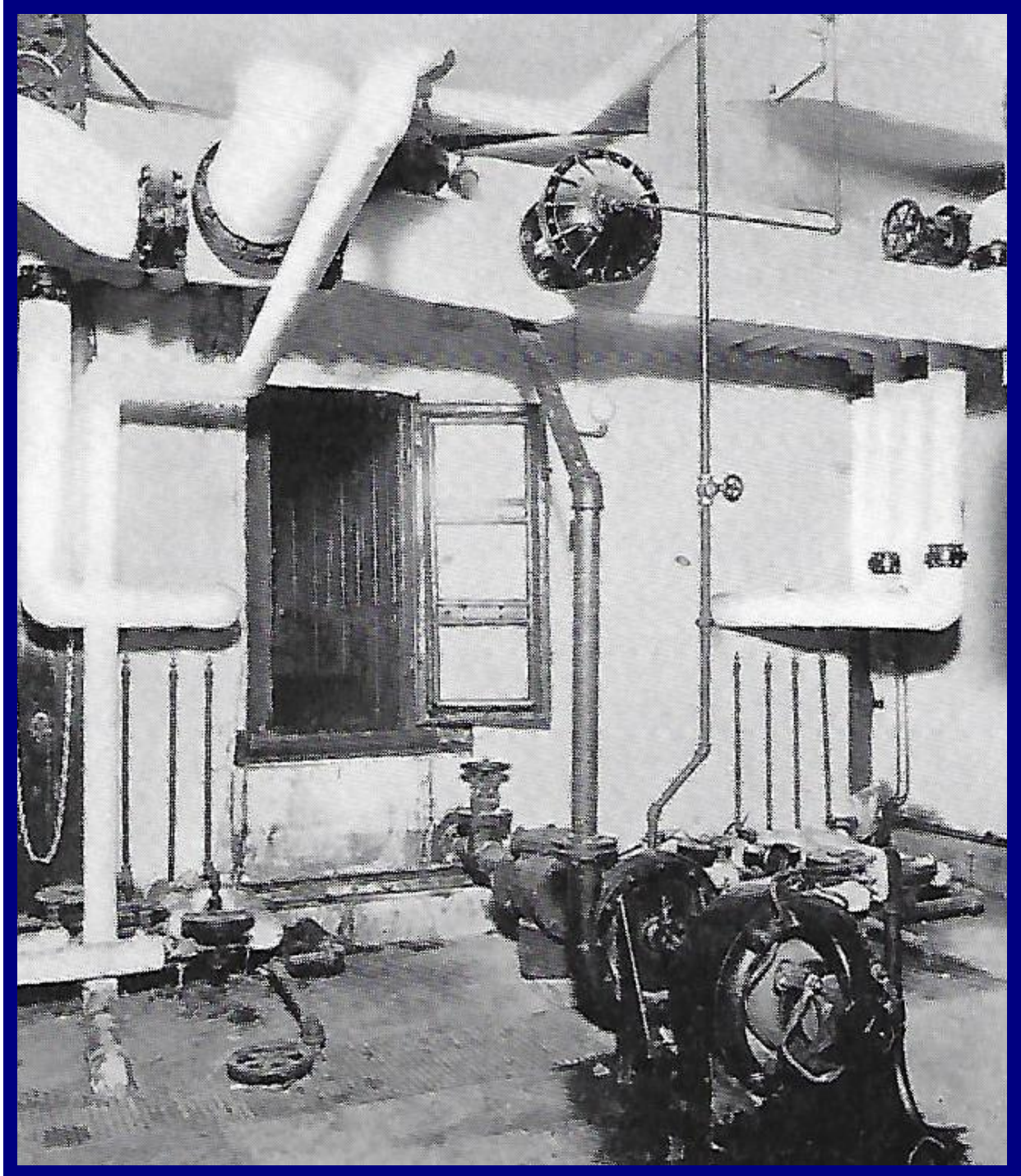

Typical 'Kinealy' air washer and spray pump.

Certain Basement areas named as "rathskeller, engine room, barber shop and banking rooms are receiving purified 'washed' air through the 'Kinealy' air washers which the company has installed. The 'Kinealy' air washers purify and cool all the air delivered wherever installed."

WANAMAKER DEPARTMENT STORE



WANAMAKER DEPARTMENT STORE



WANAMAKER DEPARTMENT STORE

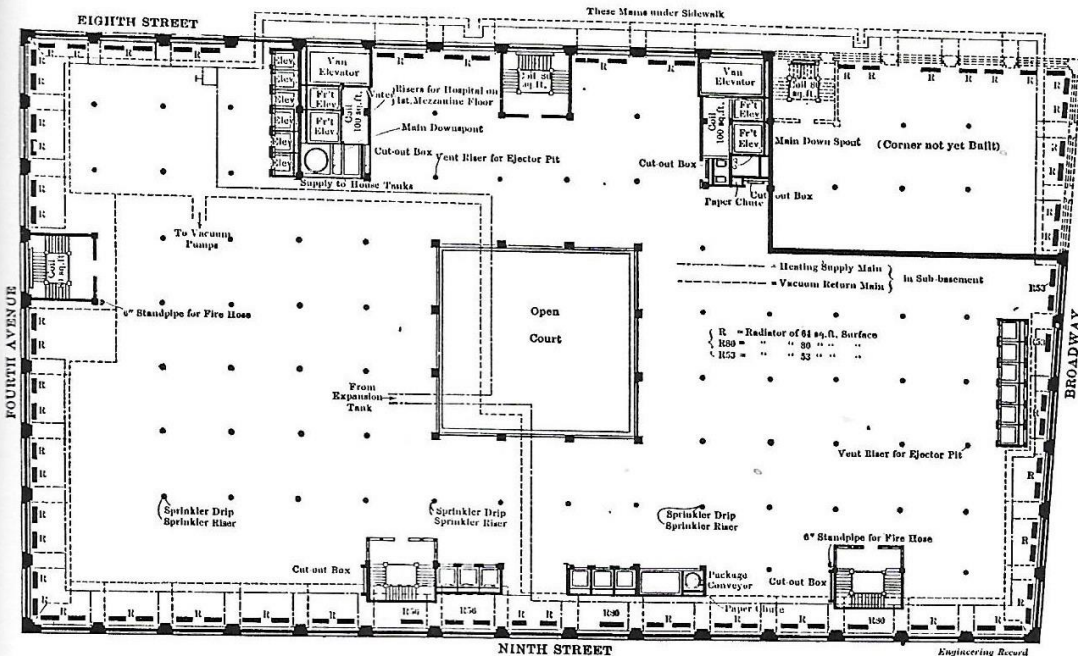

Typical Floor Plan of New Wanamaker Store Building Showing Distribution of Direct Radiation.

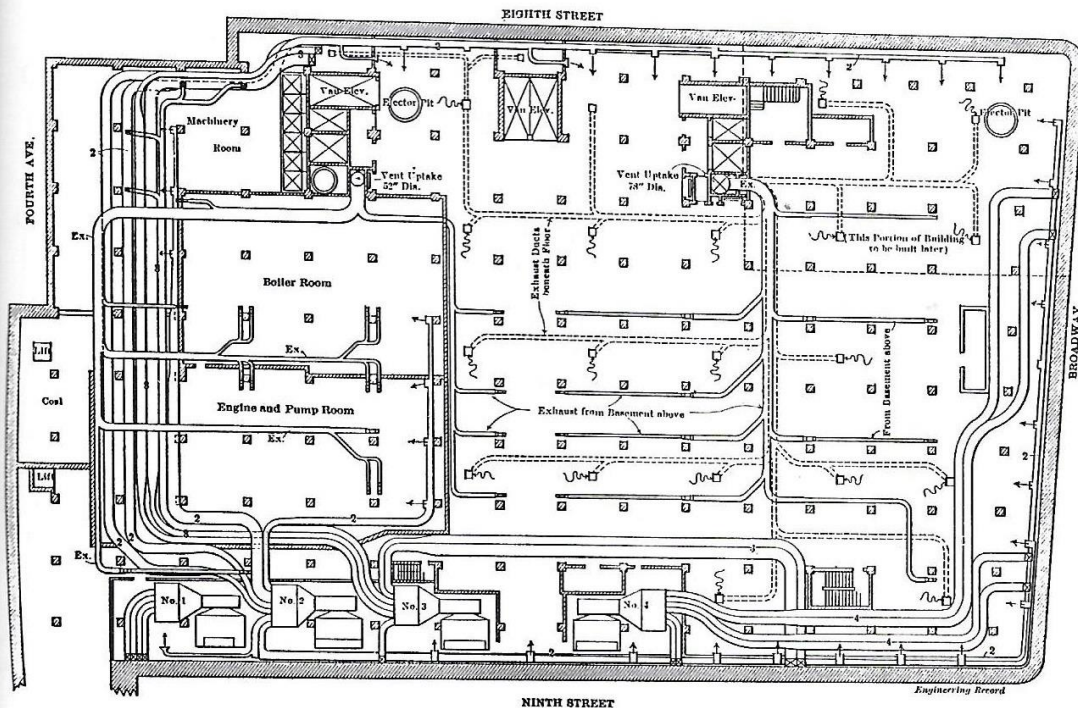

Arrangement of Blower Systems and Ductwork in Sub-basement, Wanamaker Store Building.

WANAMAKER DEPARTMENT STORE

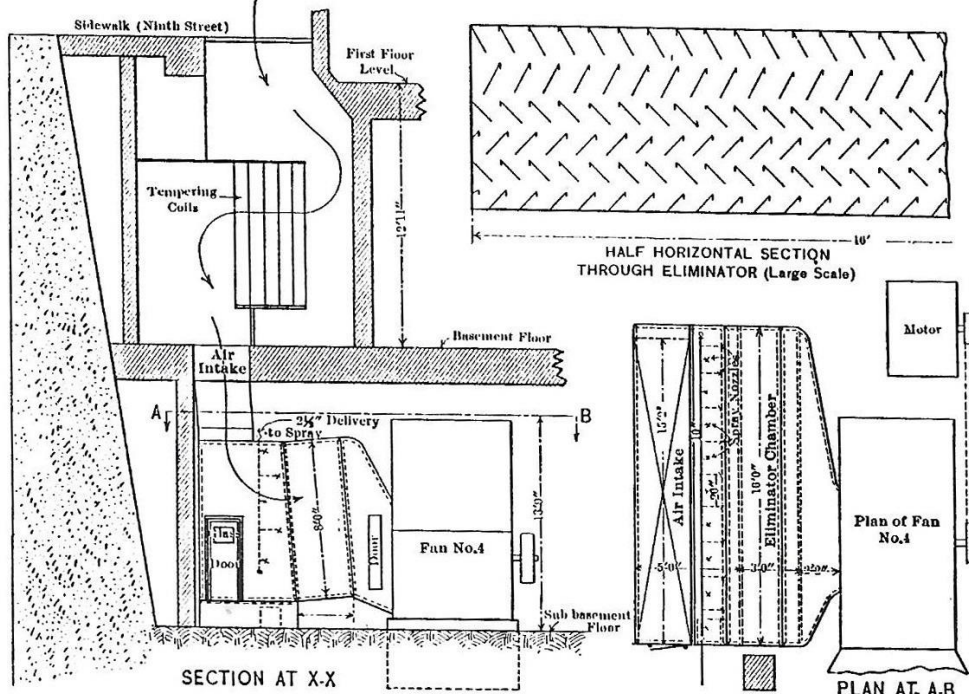

Section Under Sidewalk at Blower System No. 4, Showing Intake and Air-washing Apparatus.

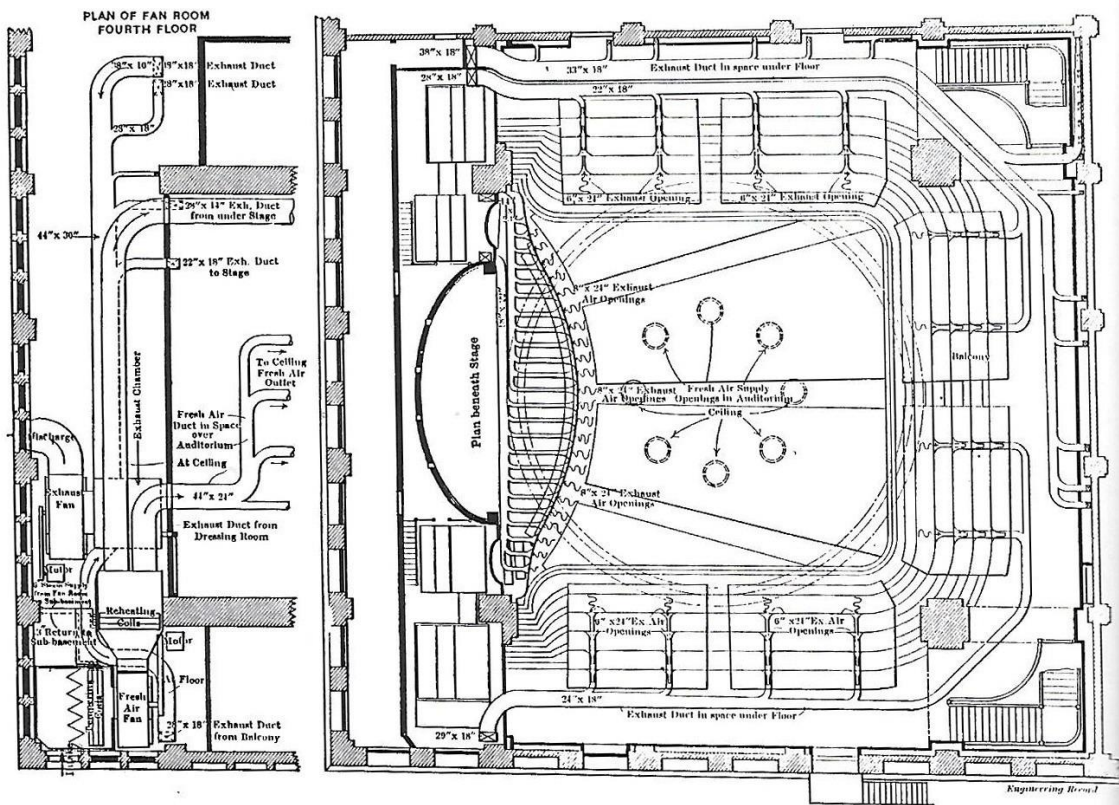

Details of Heating and Ventilating Equipment of Music Hall, New Wanamaker Store.

ELLIS ISLAND IMMIGRATION HALL

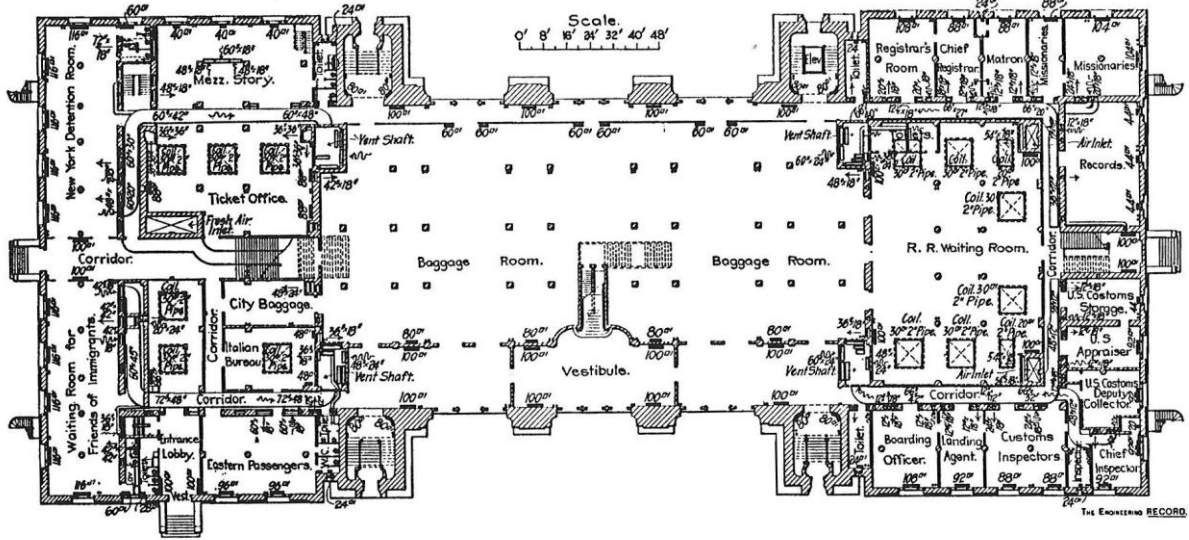

FIRST-FLOOR PLAN, MAIN BUILDING, ELLIS ISLAND, N. Y.

1901.

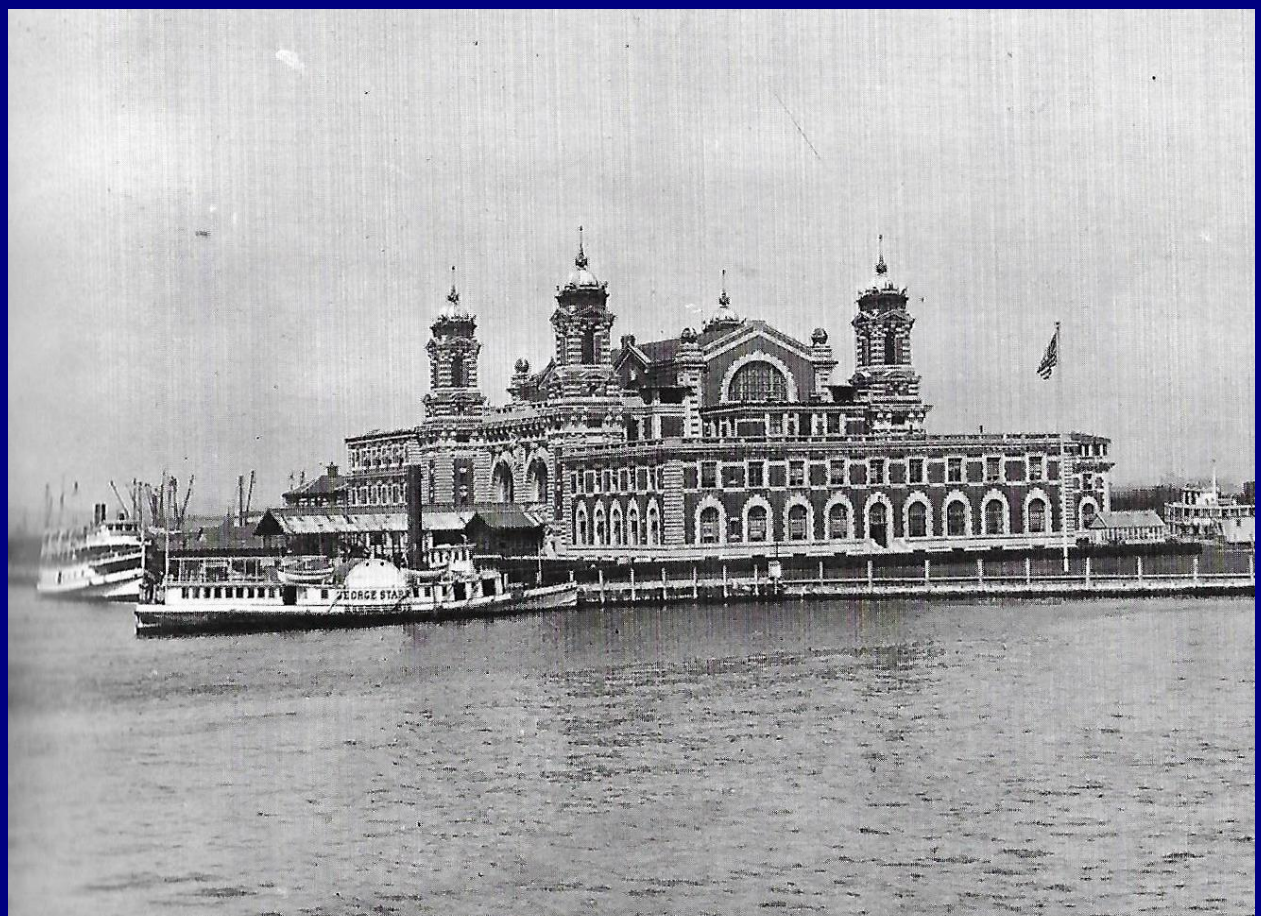

UNKNOWN PHOTOGRAPHER/ELLIS ISLAND, c. 1905/CULVER PICTURES, INC.

ELLIS ISLAND



UNKNOWN PHOTOGRAPHER/IMMIGRANTS ARRIVING AT ELLIS ISLAND, c. 1905/CULVER PICTURES, INC.

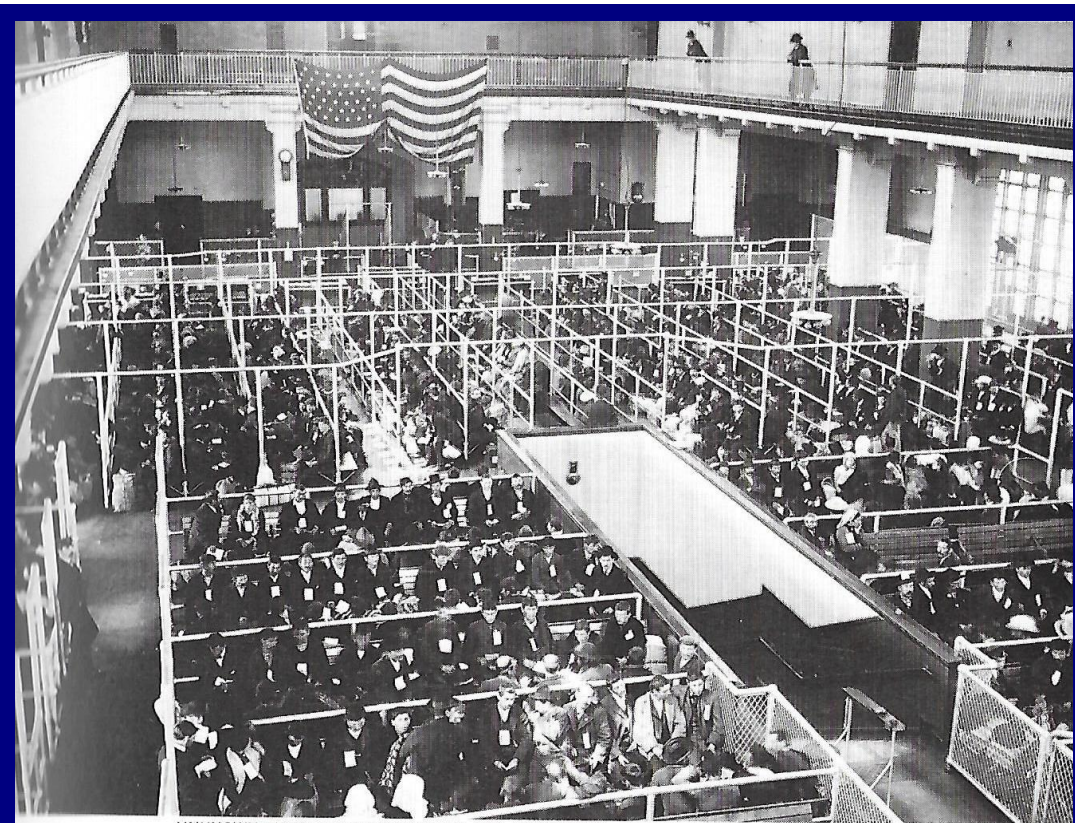

UNKNOWN PHOTOGRAPHER/WAITING AND PROCESSING, ELLIS ISLAND, c. 1910/NEW YORK PUBLIC LIBRARY

COOPER UNION

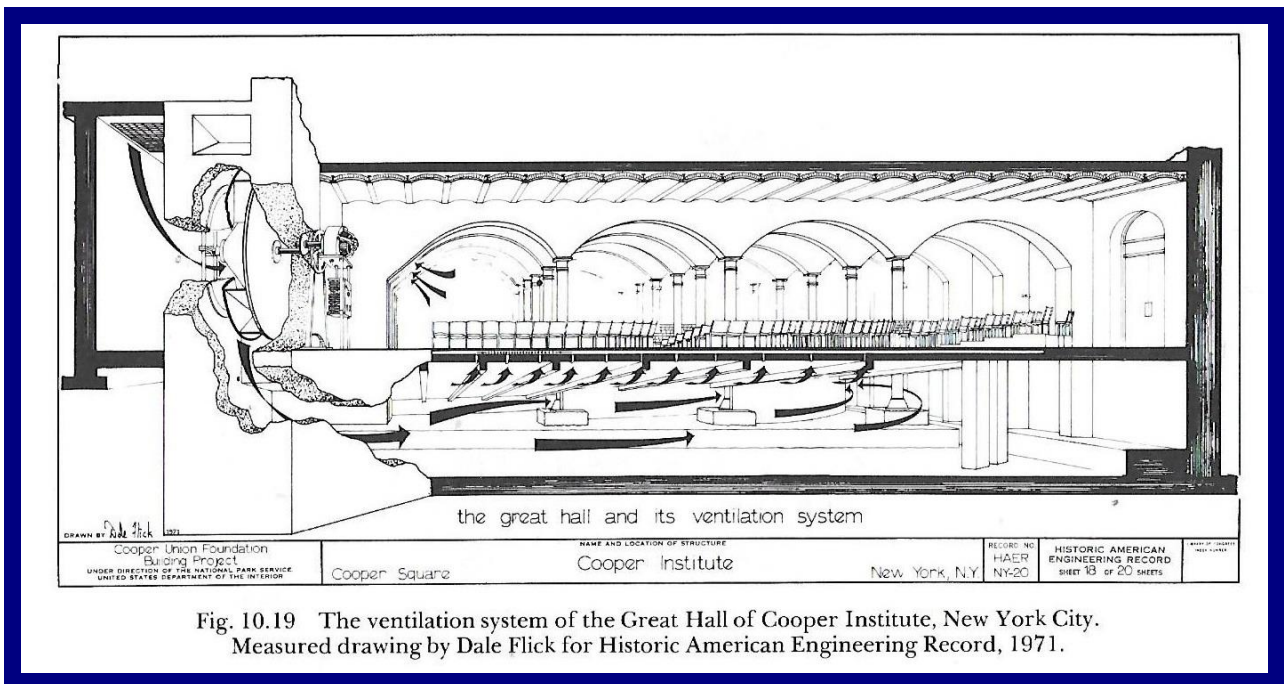
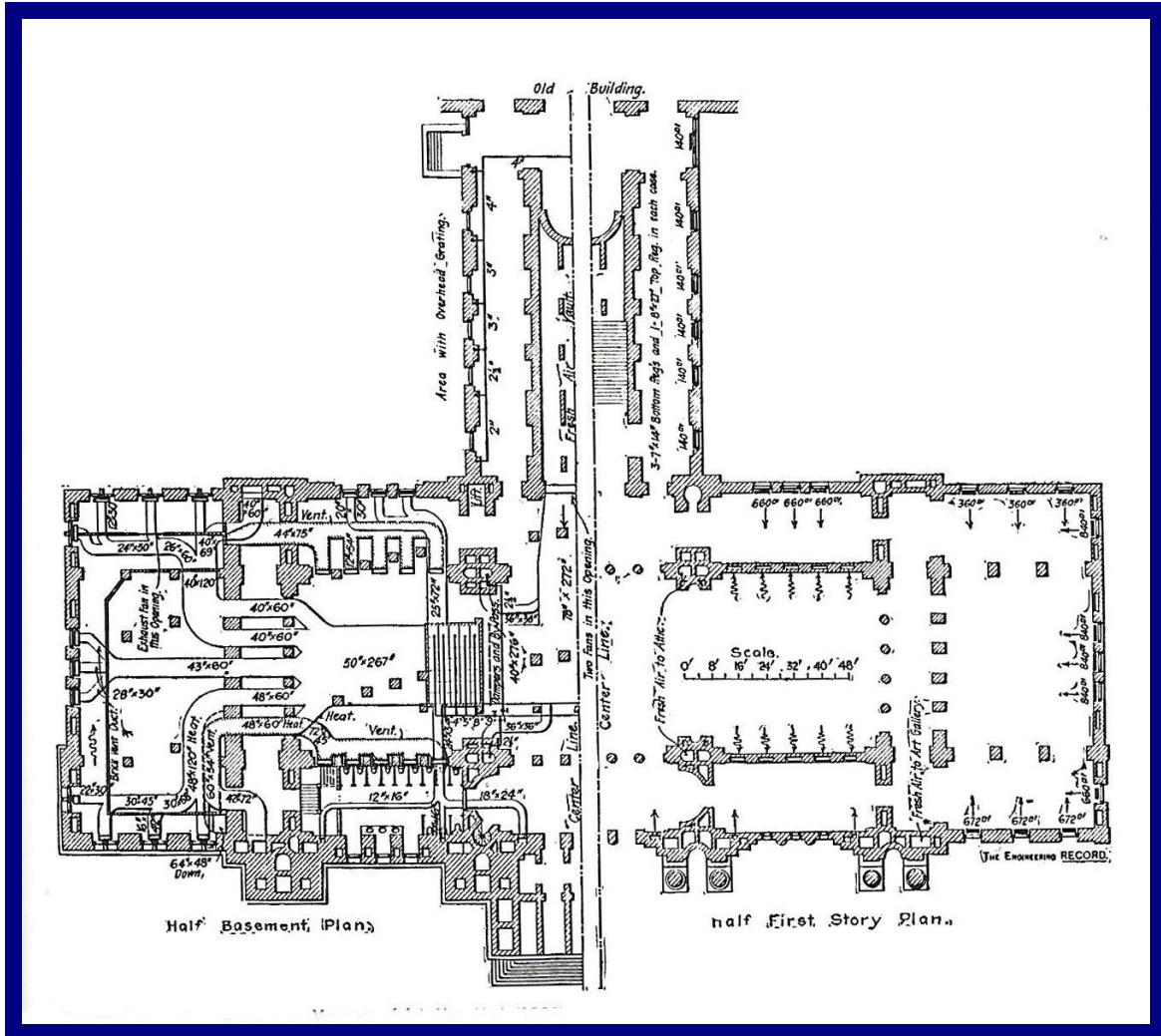

Fig. 10.19 The ventilation system of the Great Hall of Cooper Institute, New York City. Measured drawing by Dale Flick for Historic American Engineering Record, 1971.

Drawing of 1971 showing original ventilation system of 1889.

METROPOLITAN MUSEUM OF ART



Plan of 1900



ASTOR HOTEL



Opened 1904, 700 rooms.



The Orangerie, part of "one of Manhattan's most fashionable night spots."

ASTOR HOTEL

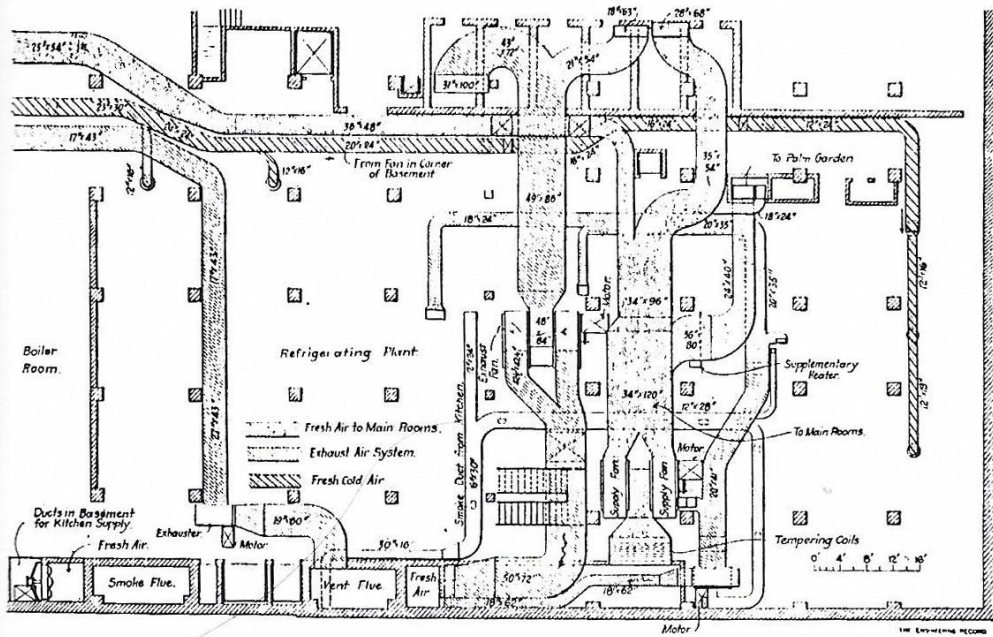

Ventilating Units in the Hotel Astor Cellar.

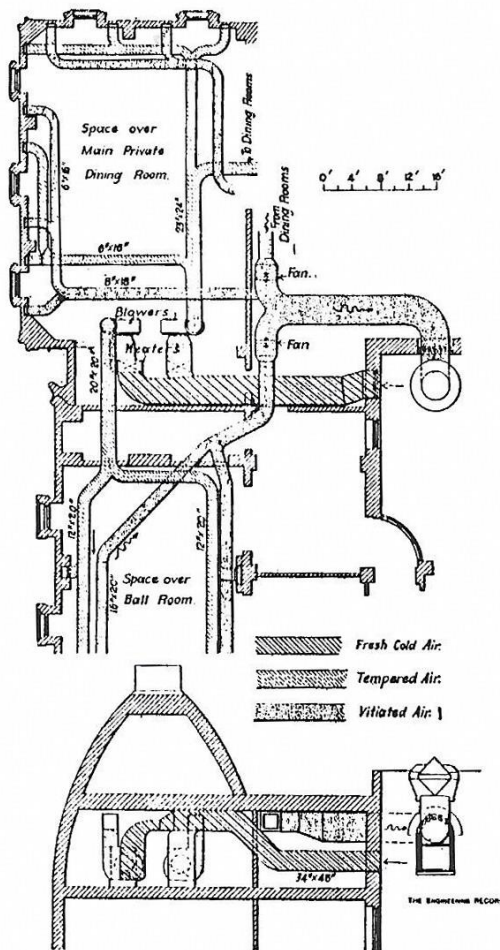

Ventilating Scheme for the Top Story Rooms.

ASTOR HOTEL

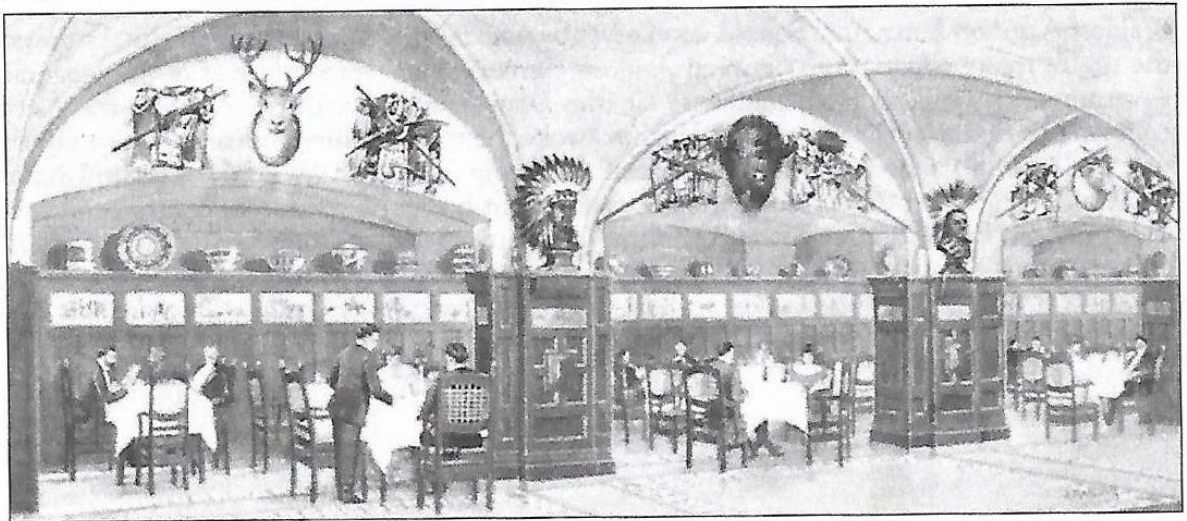
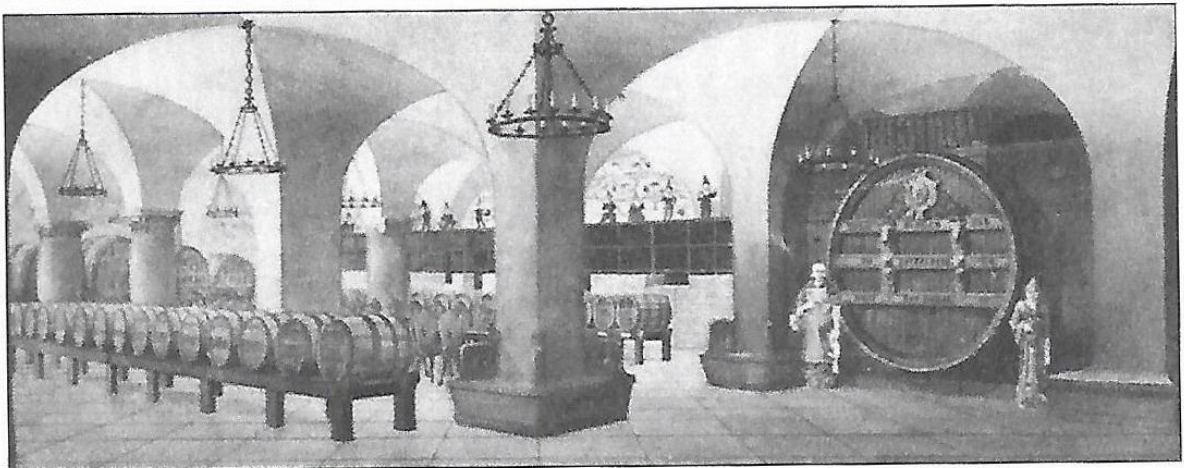

(From top): The vast kitchens; The Wine Vaults; The Indian Grill Room.

ASTOR HOTEL

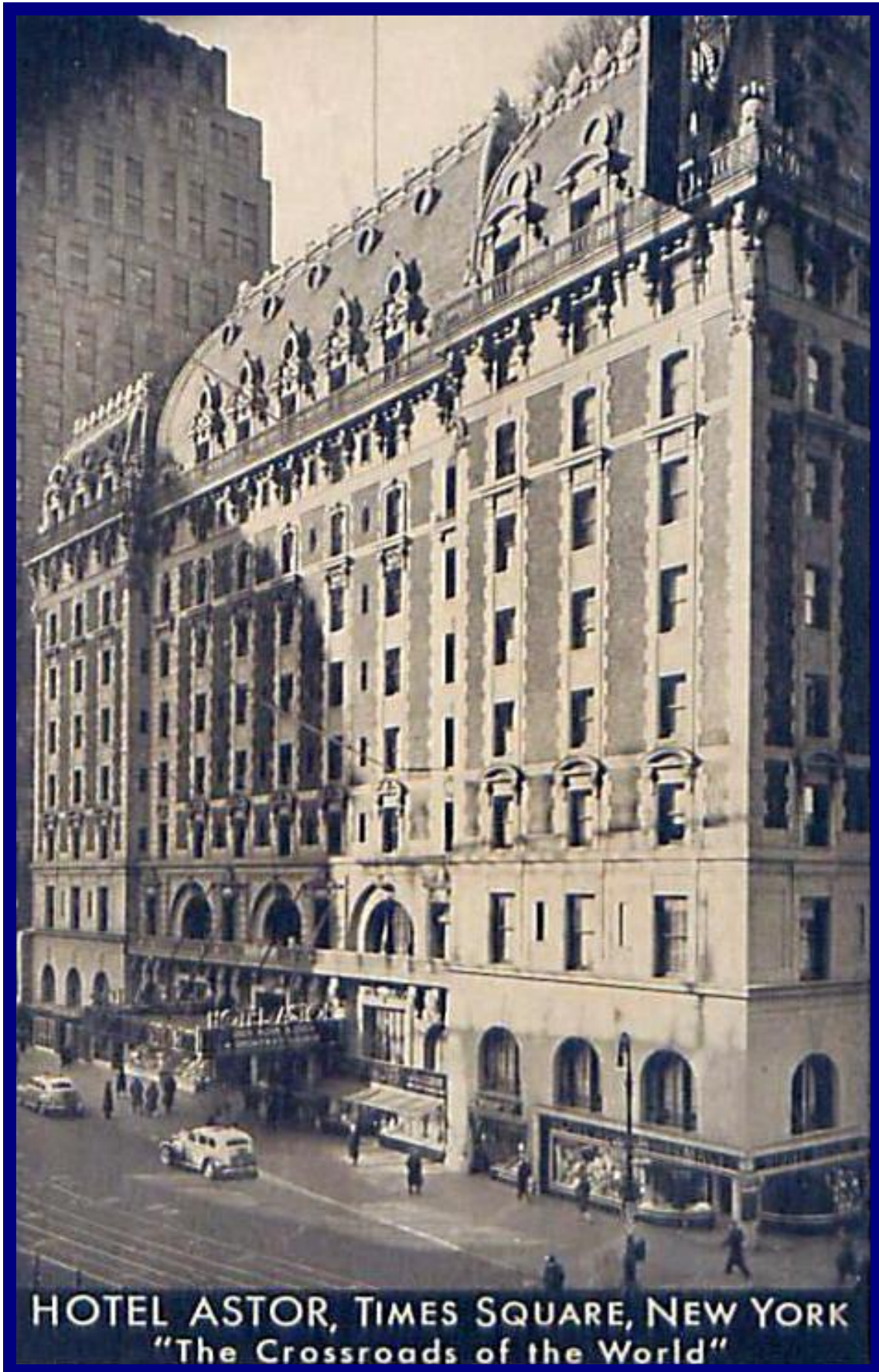

HOTEL ASTOR, TIMES SQUARE, NEW YORK
"The Crossroads of the World"

ANSONIA HOTEL



Opened 1904, 1400 rooms, 18 floors.

ANSONIA HOTEL

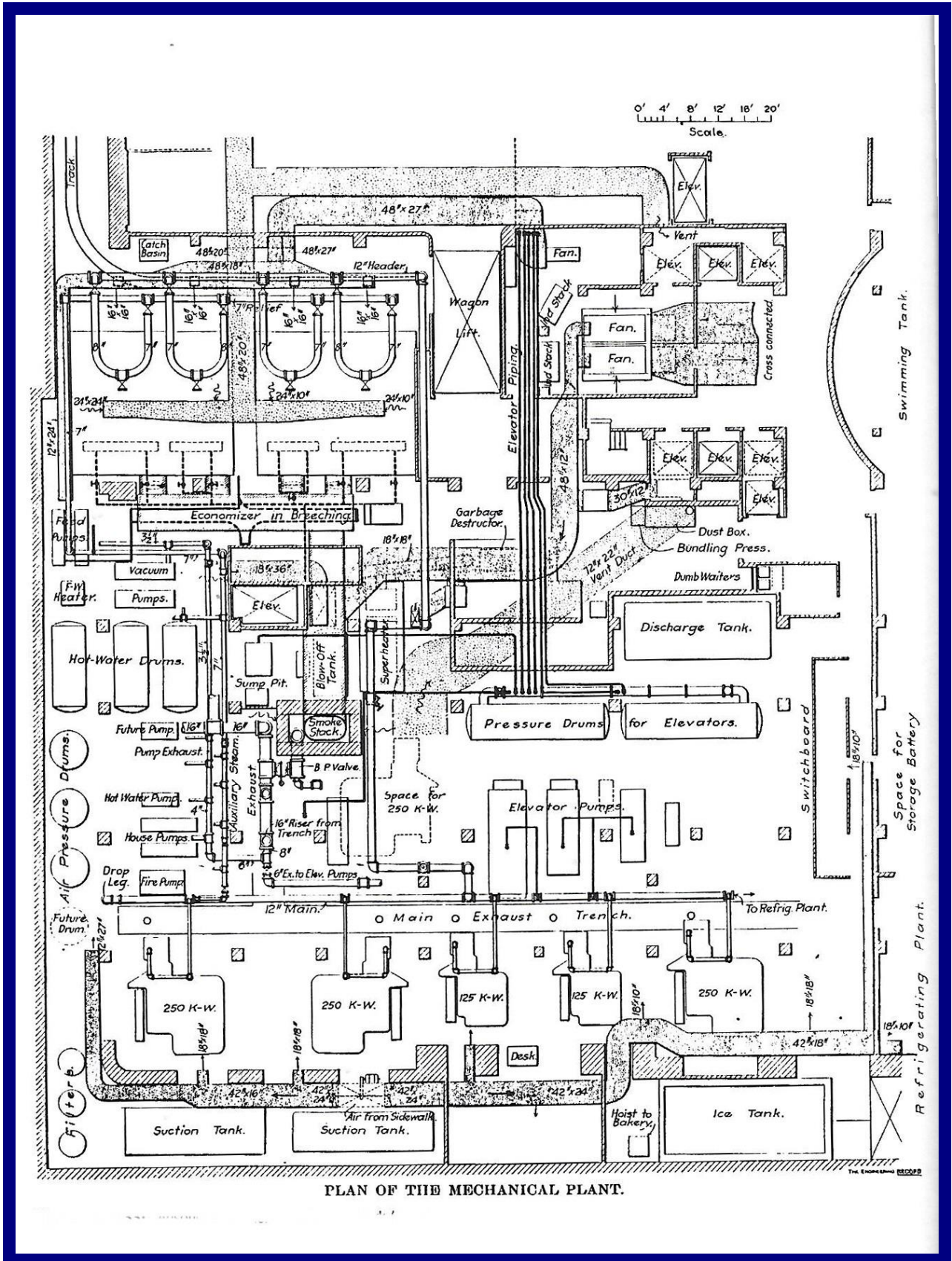

1902. (At unknown date was the first New York Hotel to be air conditioned).

HOTEL KNICKERBOCKER



Opened 1906, 330 rooms, 15 floors.

HOTEL KNICKERBOCKER

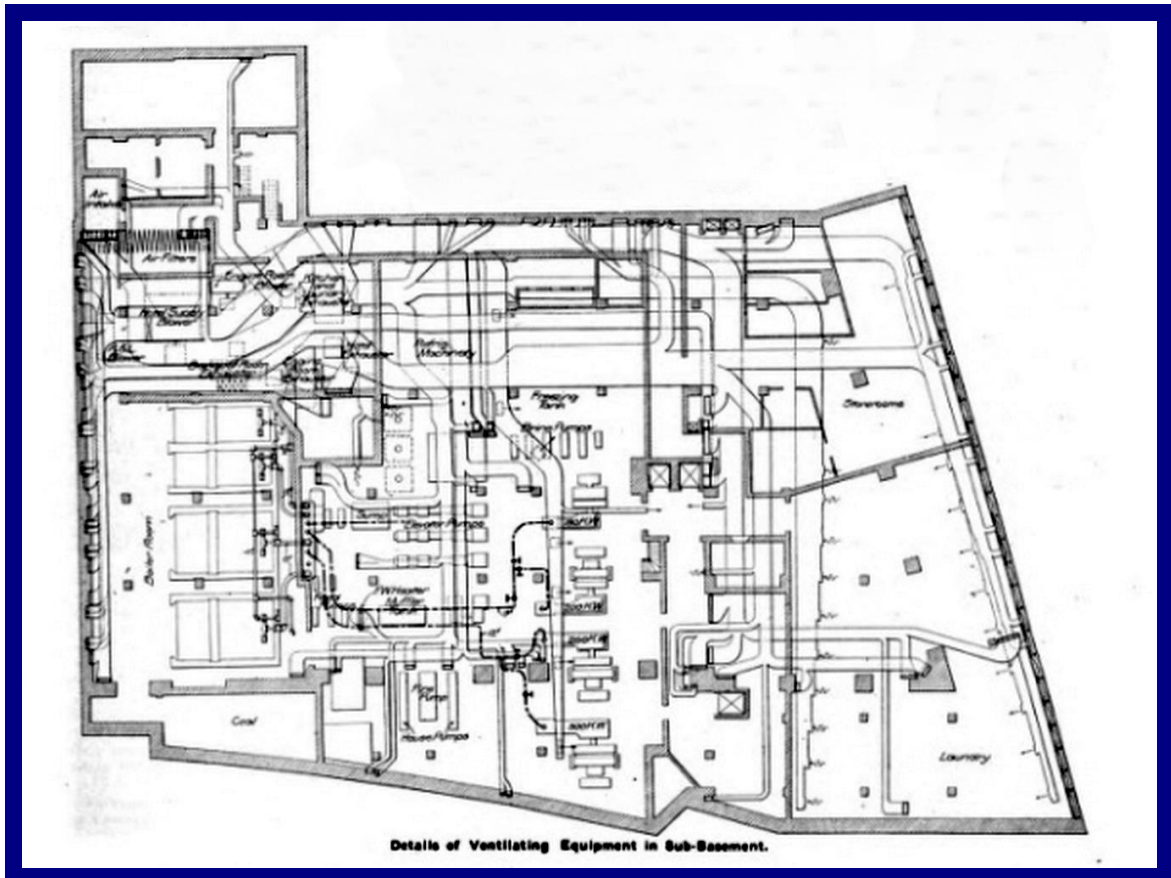
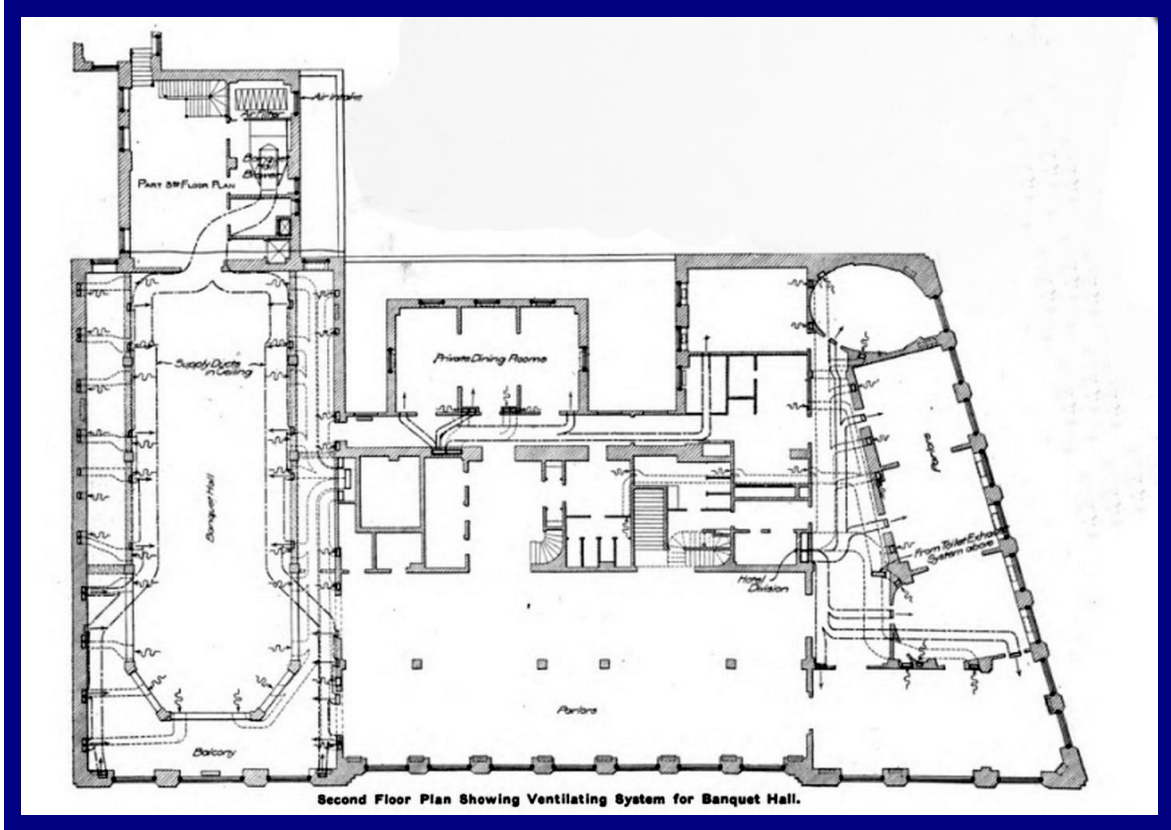

ANDREW CARNEGIE RESIDENCE



ANDREW CARNEGIE RESIDENCE

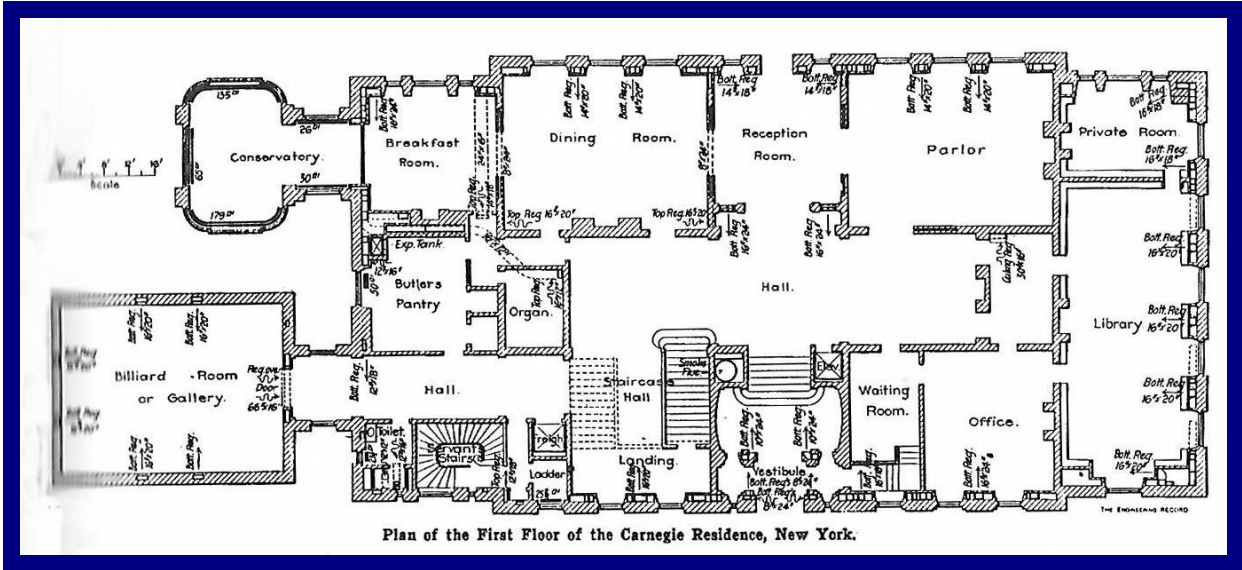

Plan of 1902.

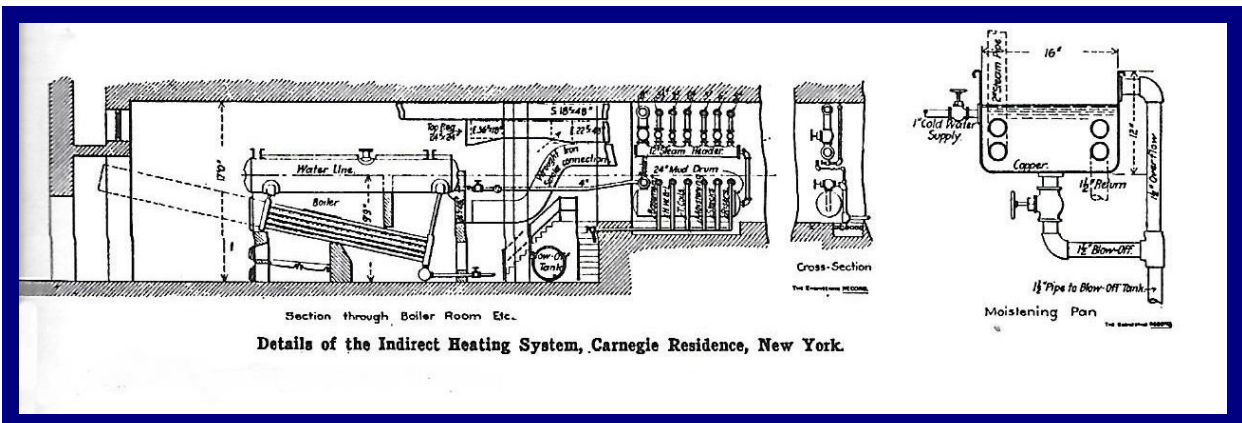
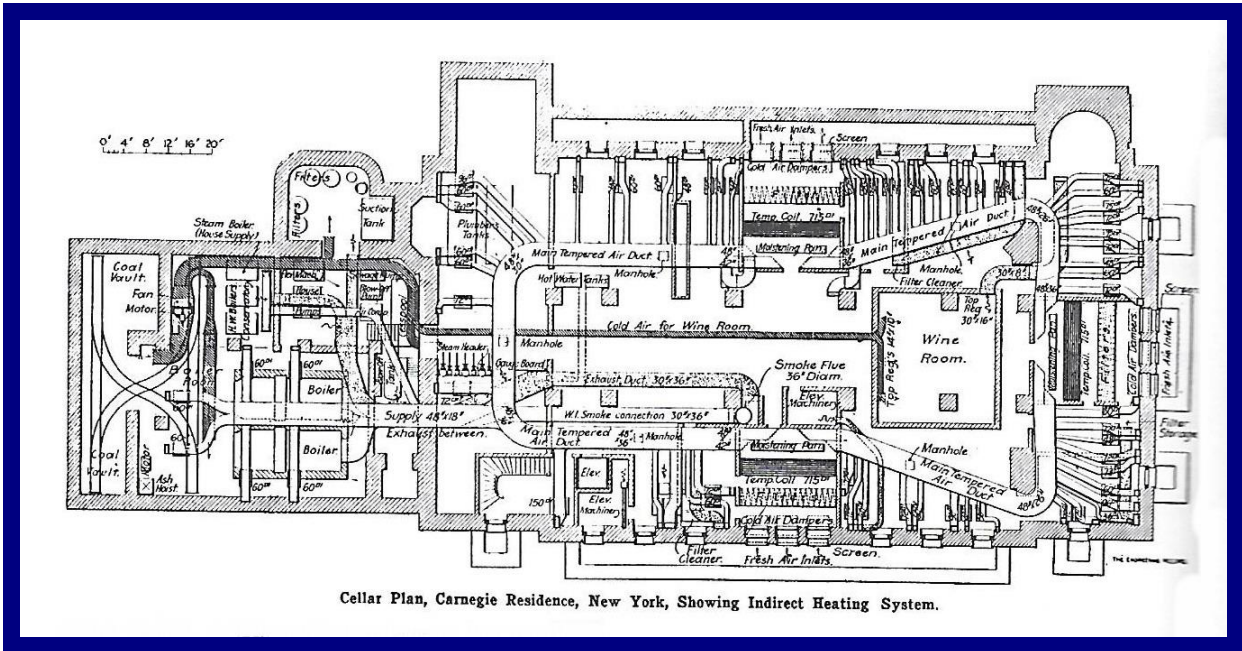

Heating System Drawings from 1903.

REFERENCES AND FURTHER READING

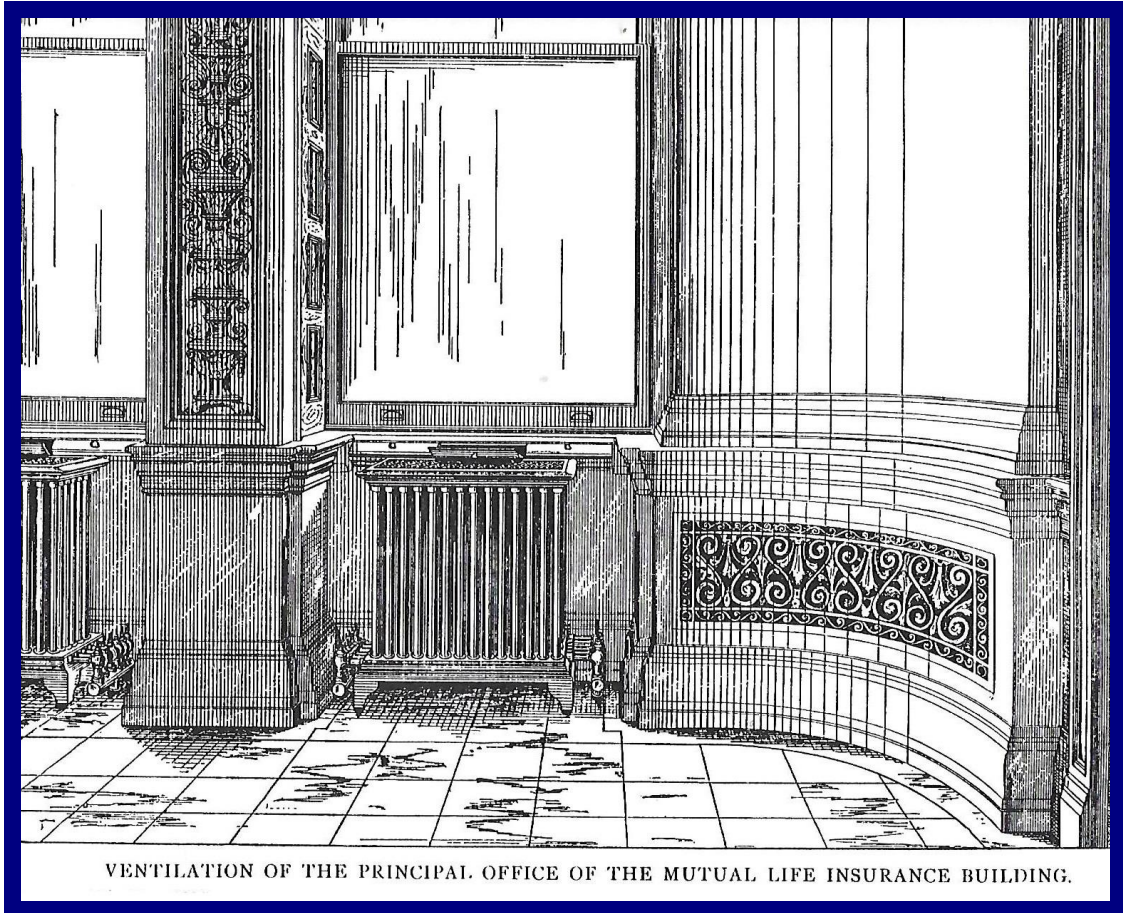

Drawing of 1894.

- 1913 *The Master Builders, A Record of the Construction of the World's Highest Commercial Structure (Woolworth Building, New York City)*, Hugh McAtamney, New York.
- 1967 *Portal to America: The Lower East Side 1870-1925*, Allon Schoener (Ed), Holt, Rinehart & Winston, New York.
- 1989 *Grand American Hotels*, Catherine Donzel & Alexis Gregory, The Vendome Press, New York.
- 1992 *Mechanical & Electrical Systems for Historic Buildings*, Gersil Kay, McGraw-Hill, New York.
- 1995 *Form Follows Function (Skyscrapers and Skylines in New York....)*, Carol Willis, Princeton Architectural Press, New York.
- 1997 *Manhattan Hotels 1880-1920*, Jeff Hirsh, (Images of America), Arcadia Publishing, Charleston, South Carolina.
- 2007 *Hotel: An American History*, A. K. Sandoval-Strausz, Yale University Press, New Haven.
- 2013 *Skyscrapers*, Judith Dupre, Black Dog & Leventhal, New York.
- 2016 *NY Skyscrapers*, Dirk Stichweh (from the German), Prestel Publishing, New York.
- 2019 *New York Then and Now*, Marcia Reiss, Pavilion Books, London.
- 2021 *20th Century Air Conditioning*, David Arnold, ASHRAE.

HVAC System and Equipment Plans, Sections and Drawings are from *The Engineering Record* magazine of New York. Other information from the Heritage Group Archive and website.