

US PATENTS
RADIATORS 1876-1928

F. TUDOR.
STEAM RADIATOR.

No. 185,146.

Patented Dec. 5, 1876.

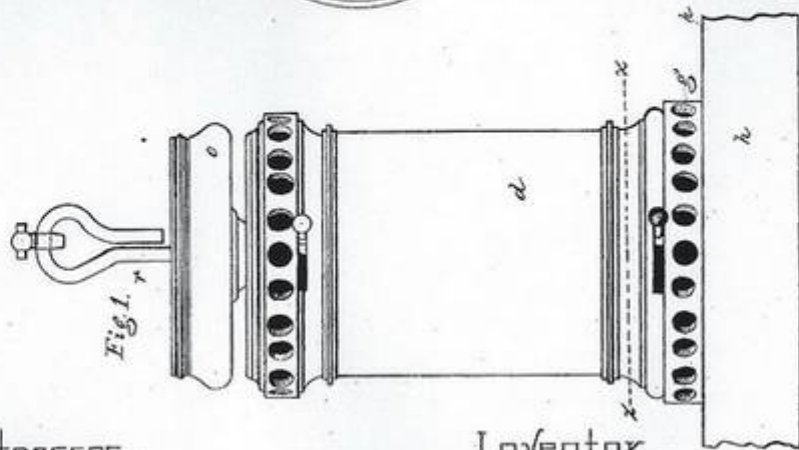
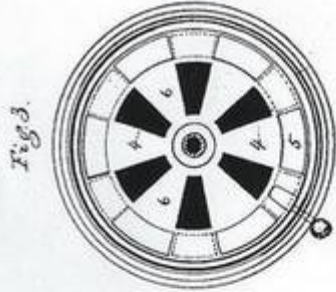
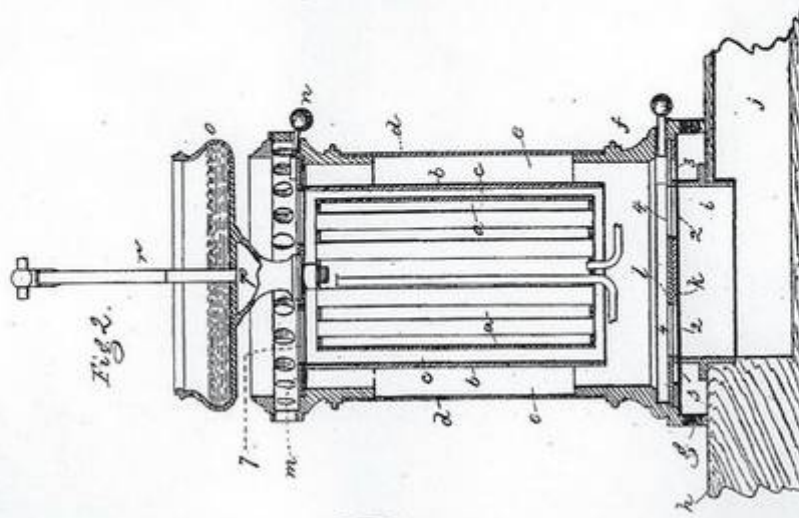

Witnesses.
L. W. Stratton.
H. J. Pratt.

Inventor.
Frederic Tudor
per Lewis Gregory attys.

(No Model.)

F. TUDOR.

STEAM AND HOT WATER HEATING APPARATUS.

No. 278,636.

Patented May 29, 1883.

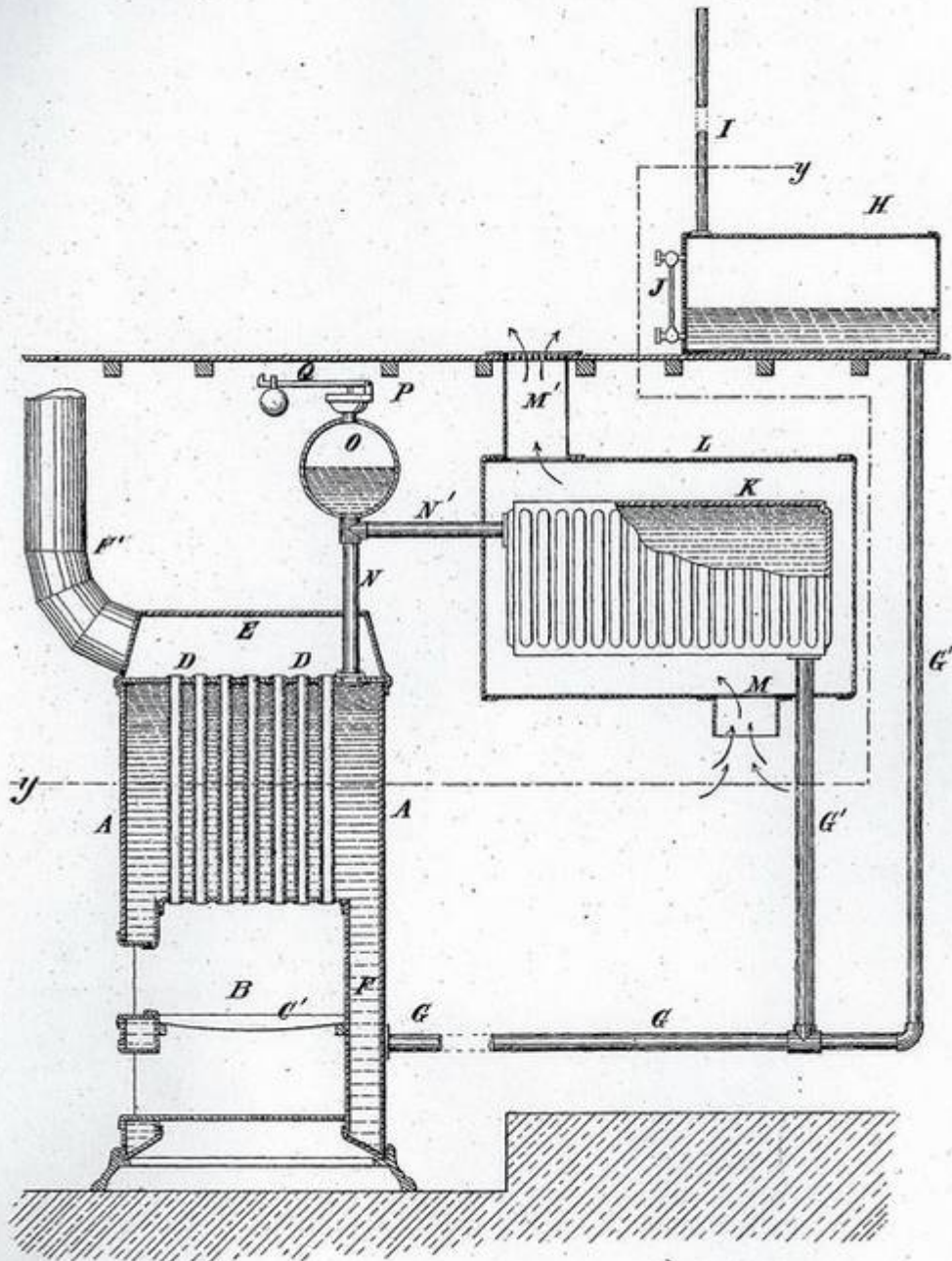

Witnesses.
Henry G. Lasker
J. B. Cravin

Inventor.
Frederic Tudor
by Chas. W. Higgins
Attorney

(No Model.)

3 Sheets—Sheet 1.

E. M. LINK.
STEAM HEATING RADIATOR.

No. 464,159.

Patented Dec. 1, 1891.

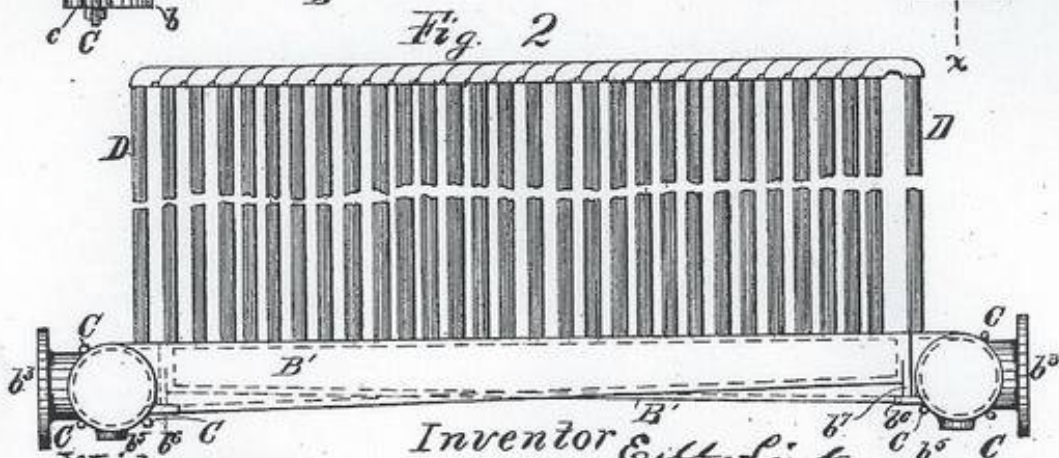
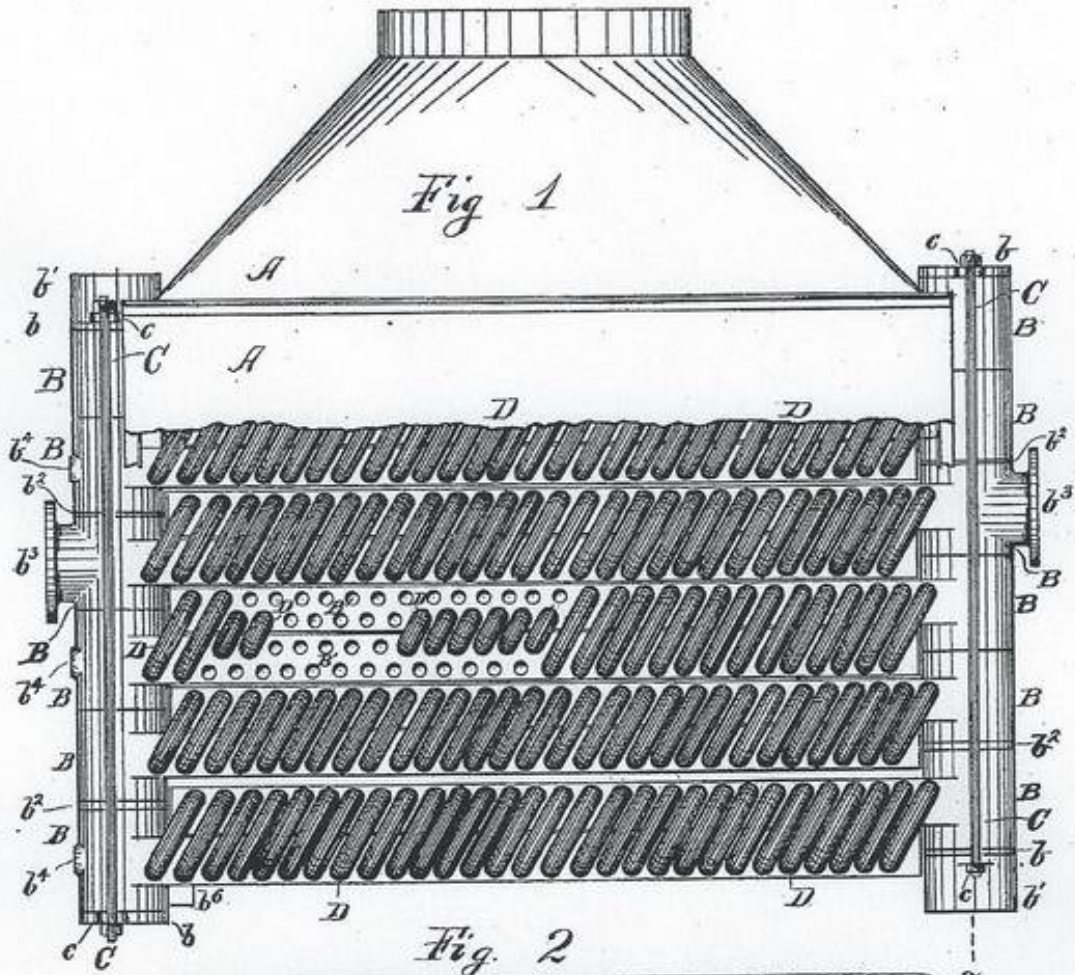

Witnesses

Inventor *E. M. Link*

Fred T. Chapman
A. W. Sturgis

Per. *Hallock & Halluck*
Attys.

(No Model.)

J. C. MACKEY.
PORTABLE STEAM RADIATOR.

No. 411,159.

Patented Sept. 17, 1889.

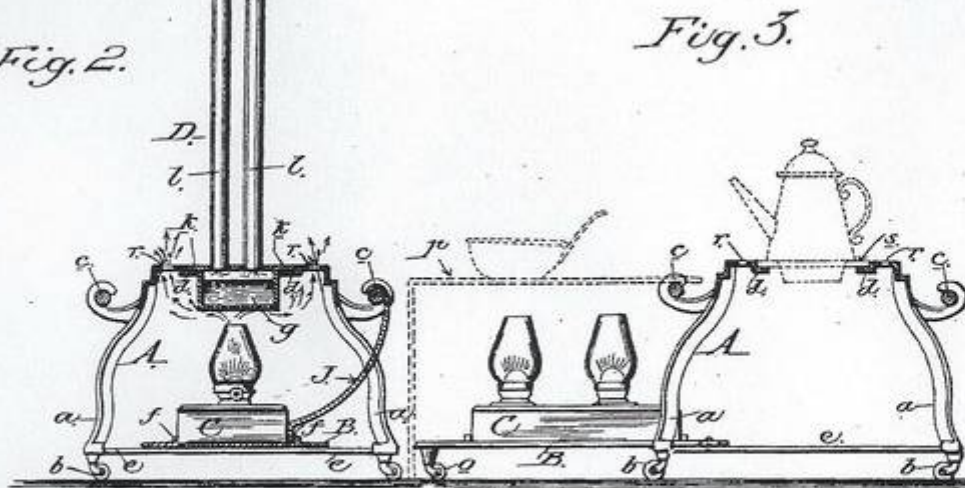
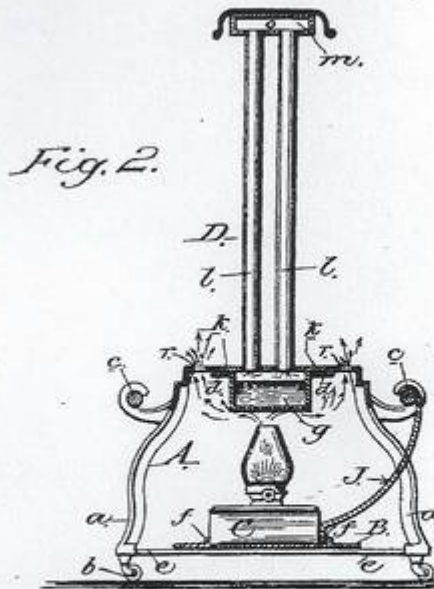
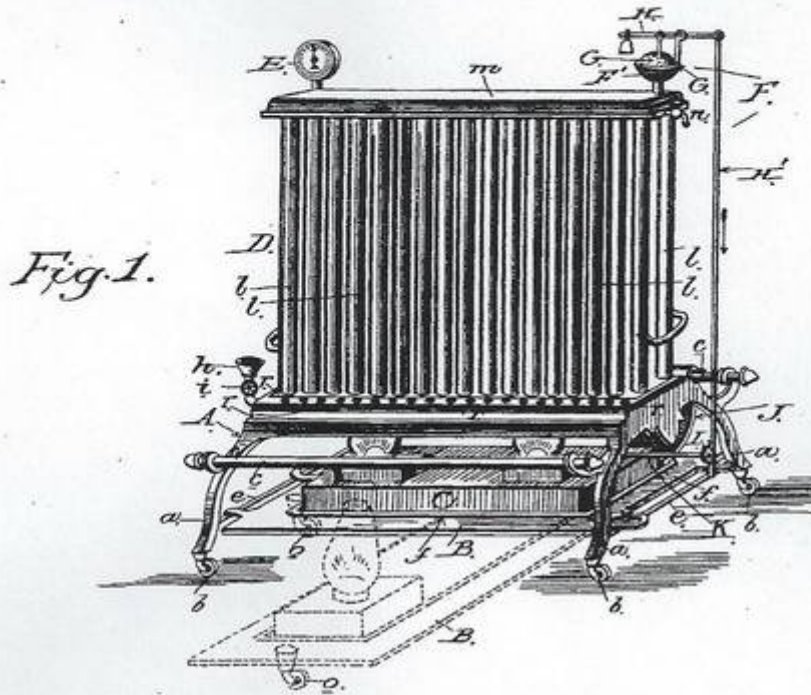

WITNESSES
J. H. Fowler,
W. H. Patterson

INVENTOR
John C. Mackey
by *A. H. Evans & Co*
His Attorneys.

(No Model.)

J. D. YOUNG.
STEAM OR HOT WATER RADIATOR.

No. 530,317.

Patented Dec. 4, 1894.

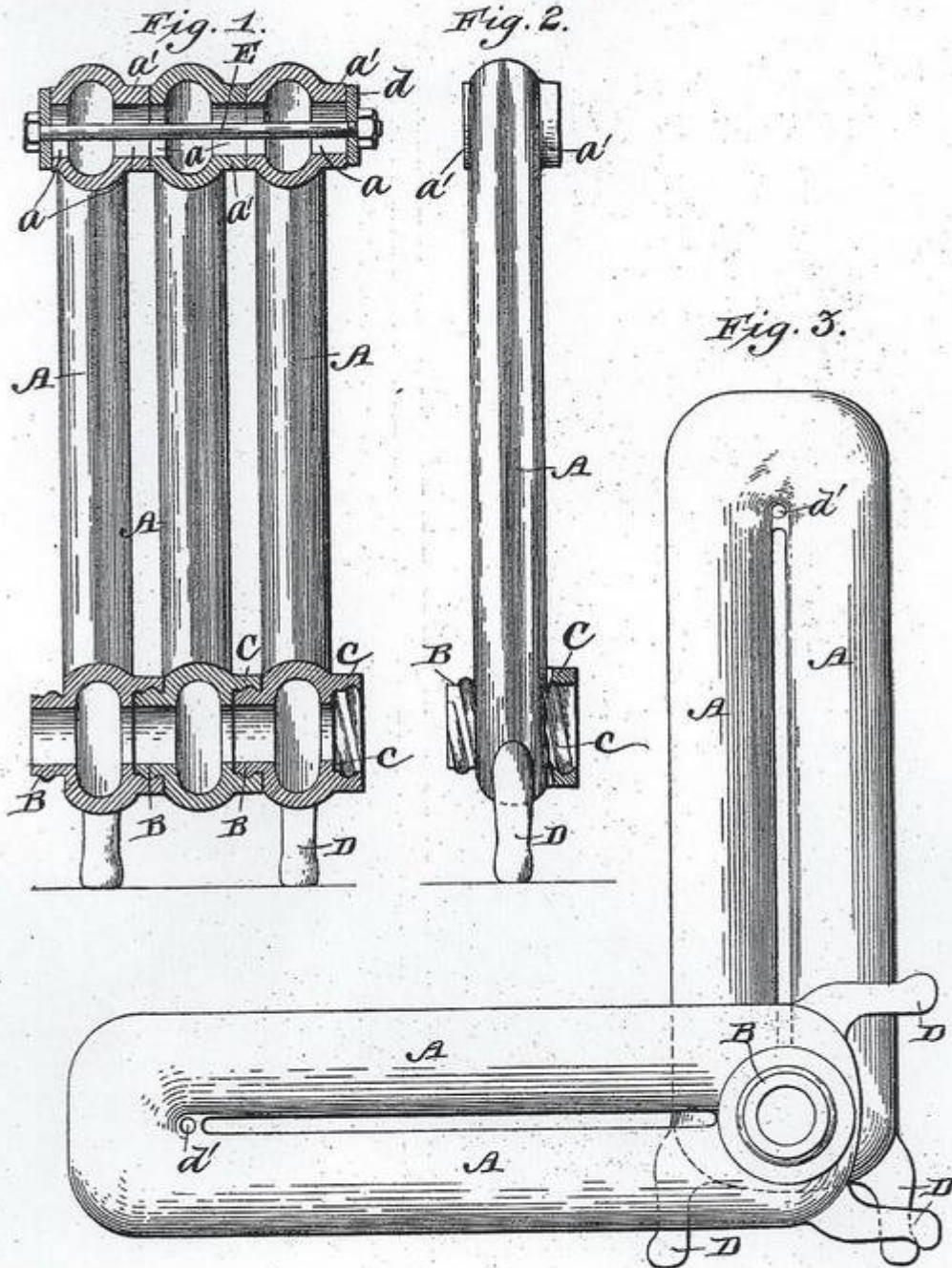

Witnesses
E. C. Clevance
W. Harvey Muzzey

Inventor
James D. Young
for
Messrs. Knickerbocker
his Attorneys

(No Model.)

J. KEITH.
RADIATOR.

No. 599,611.

Patented Feb. 22, 1898.

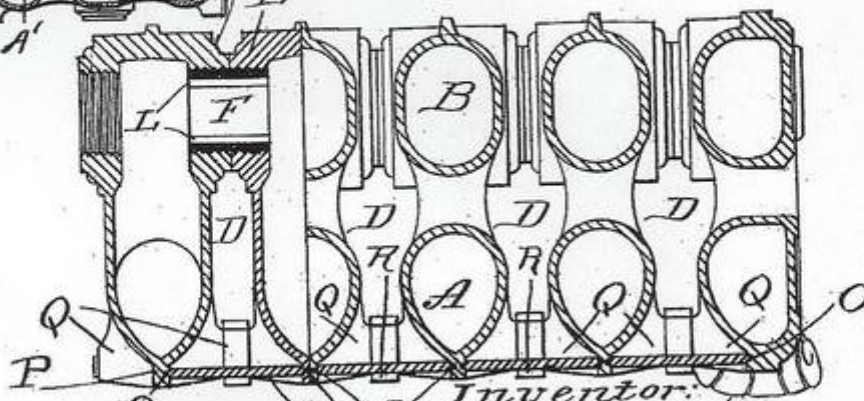
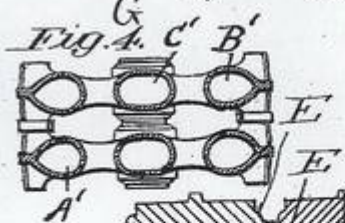
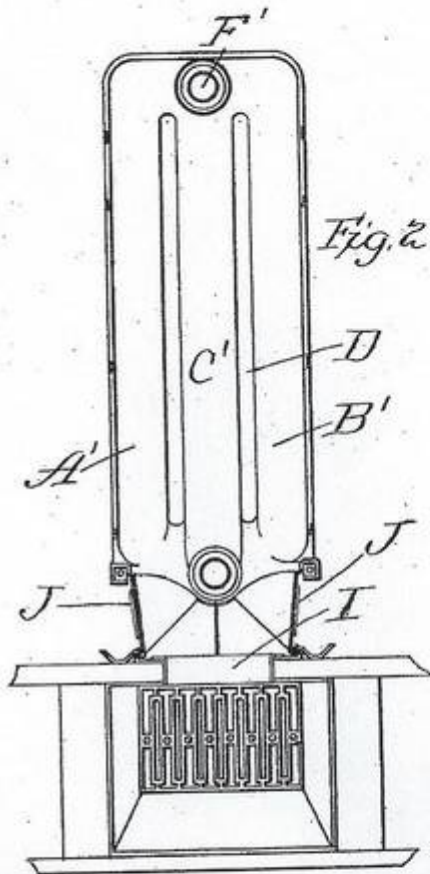
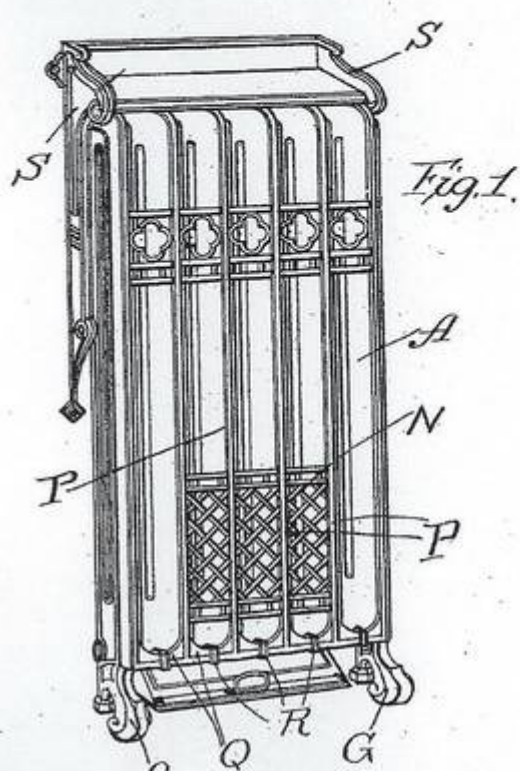

Inventor: James Keith
Witnesses: N P
E. P. Colton
O. W. Wink

BY *DeWitt*
his Attorneys.

W. ANDREWS.
HOT WATER RADIATOR.
APPLICATION FILED JULY 16, 1910.

989,751.

Patented Apr. 18, 1911.

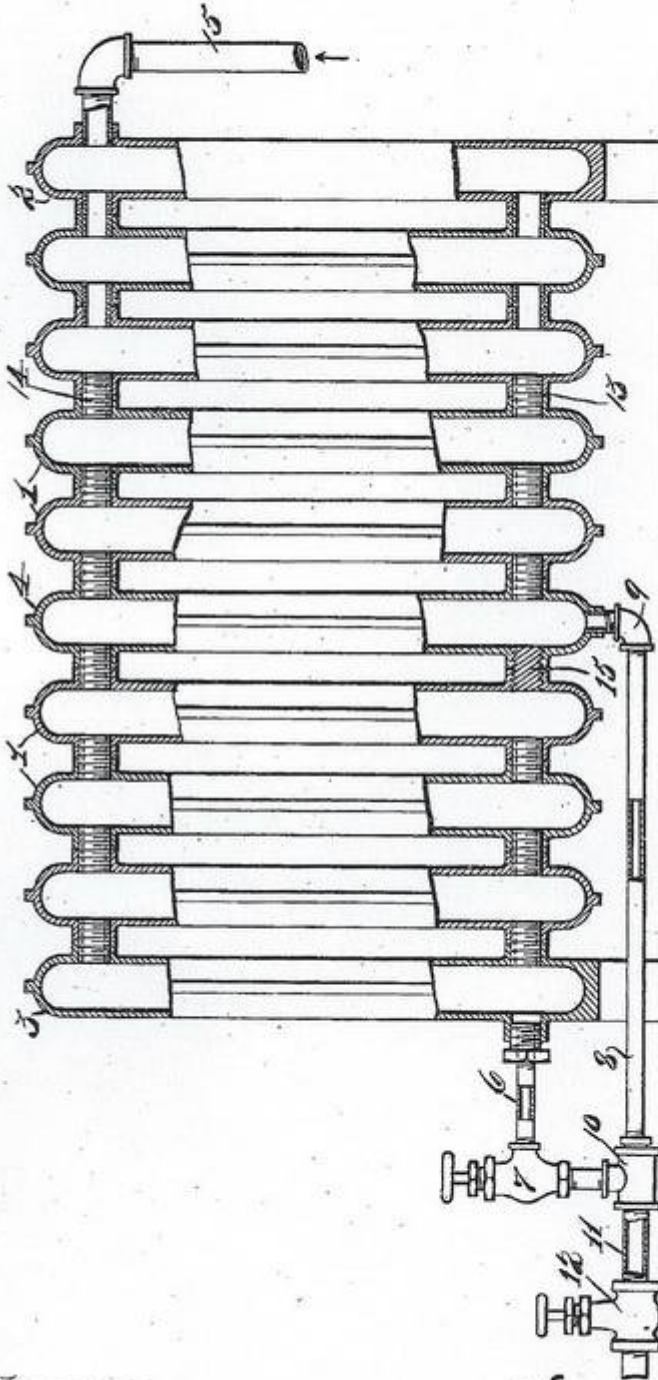

Witnesses:
C. A. Jarvis
Mabel Dittentholfer

Inventor:
William Andrews
by R. Warren Wright
attorney.

W. HAWKS.
 RADIATOR.
 APPLICATION FILED FEB. 17, 1914.

Patented Mar. 9, 1915.

1,131,372.

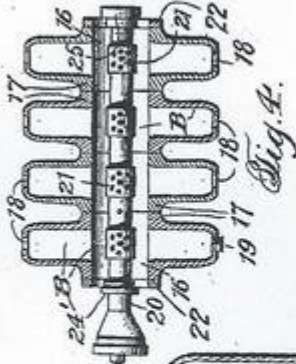

Fig. 4.



Fig. 5.



Fig. 6.

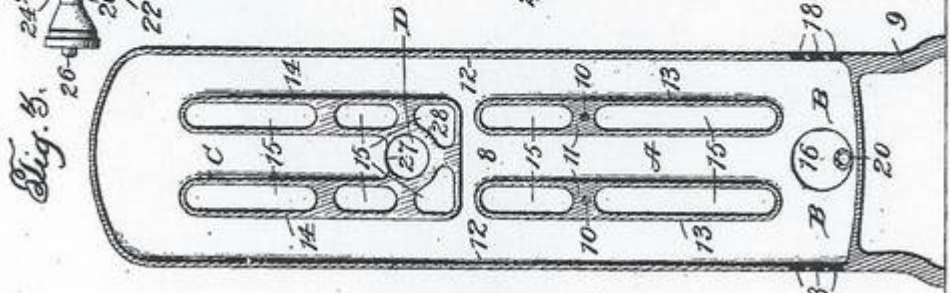

Fig. 2.

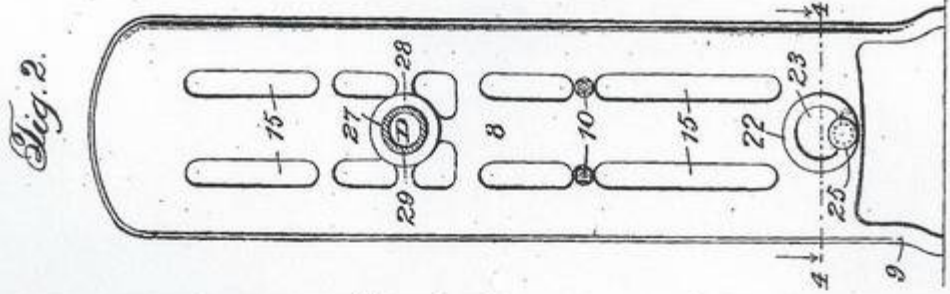

Fig. 3.

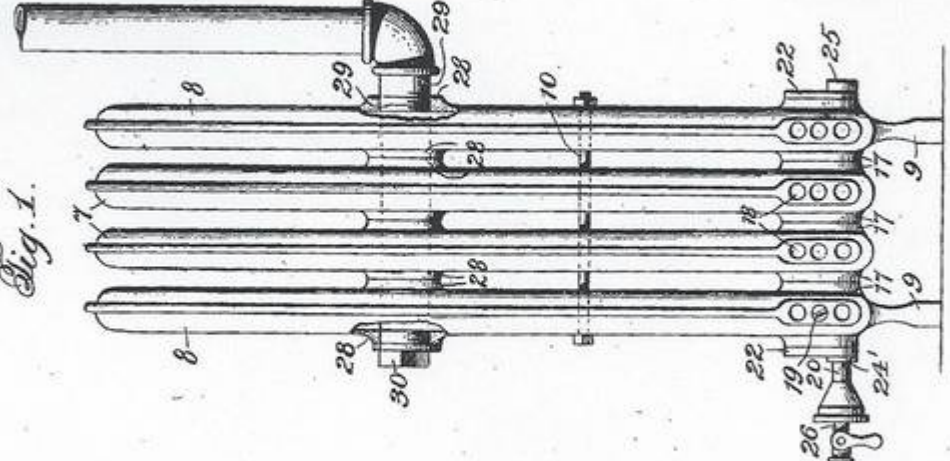

Fig. 1.

Witnesses:
James Hutchinson
Andrew B. Trudgian

Inventor
William Hawks
 by *Chauncey C. Richardson, Attorneys*

Dec. 4, 1928.

1,694,201

L. G. BOSTEDO

CONVERTIBLE STEAM AND HOT WATER RADIATOR

Filed Aug. 15, 1927

Fig. 1.

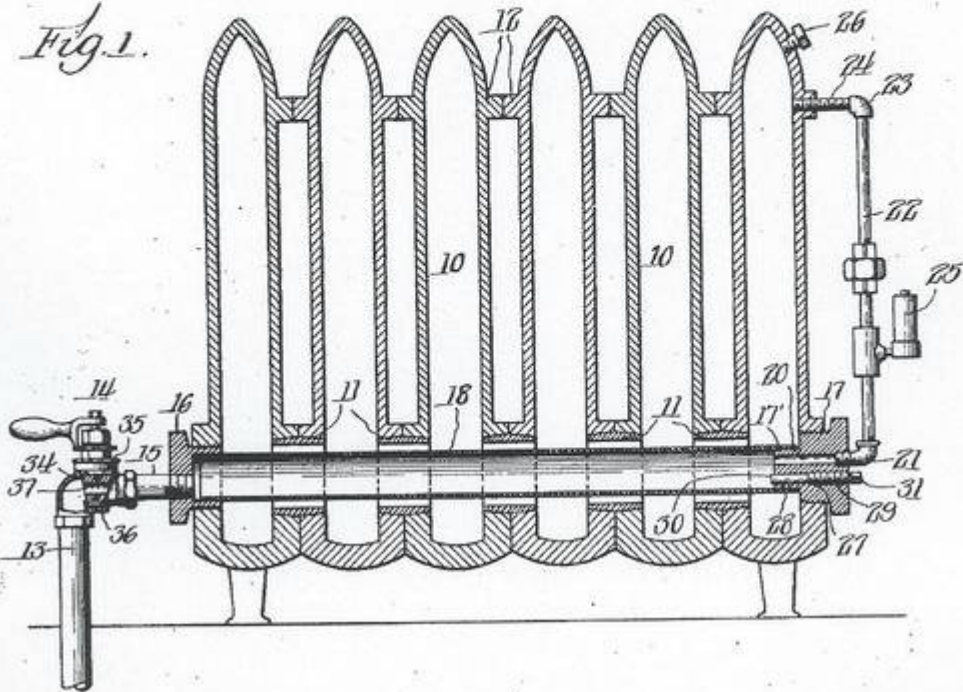
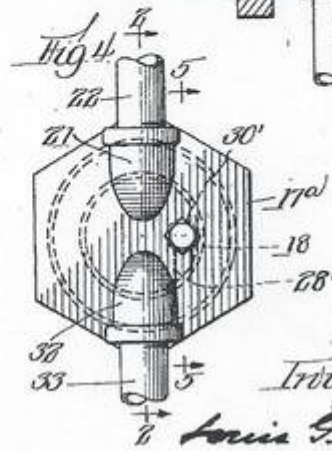
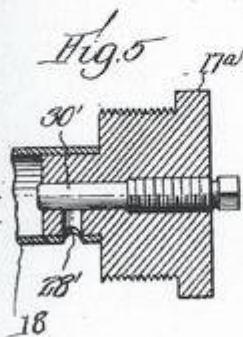
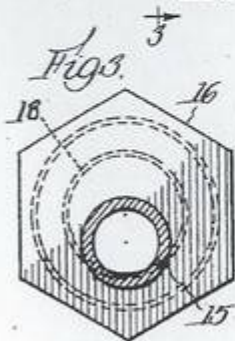
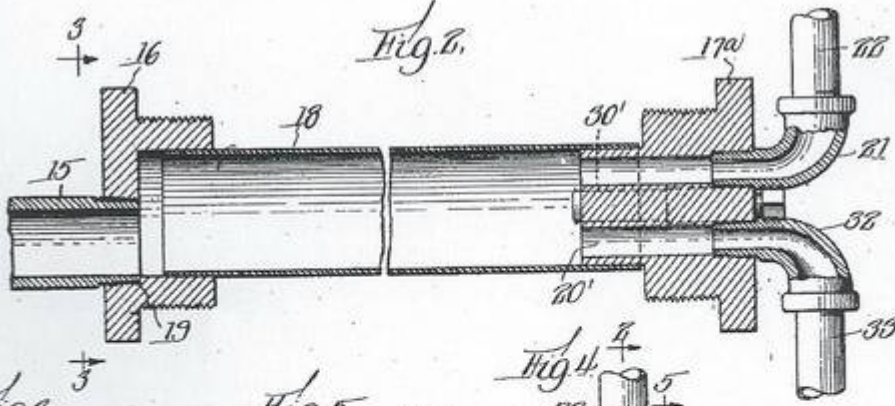

Fig. 2.



Inventor:
Louis G. Bostedo