

US PATENTS  
ELECTRICAL APPARATUS 1852-1890

(No Model.)

T. A. EDISON.

DYNAMO OR MAGNETO ELECTRIC MACHINE.

No. 263,146.

Patented Aug. 22, 1882.

Fig. 3.

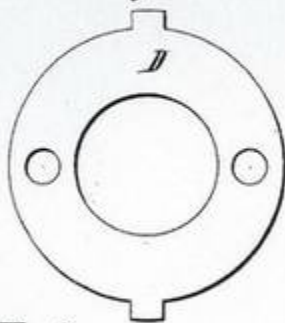

Fig. 4.

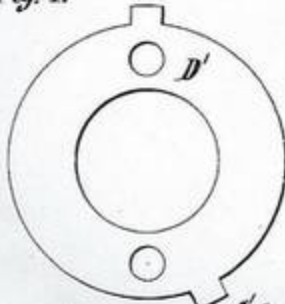

Fig. 2.

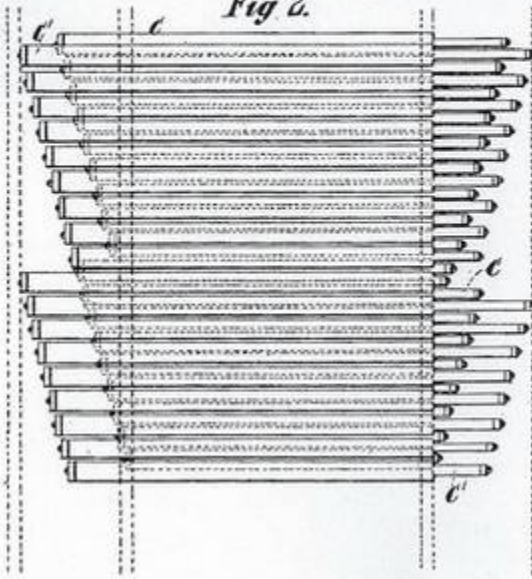

Fig. 1.

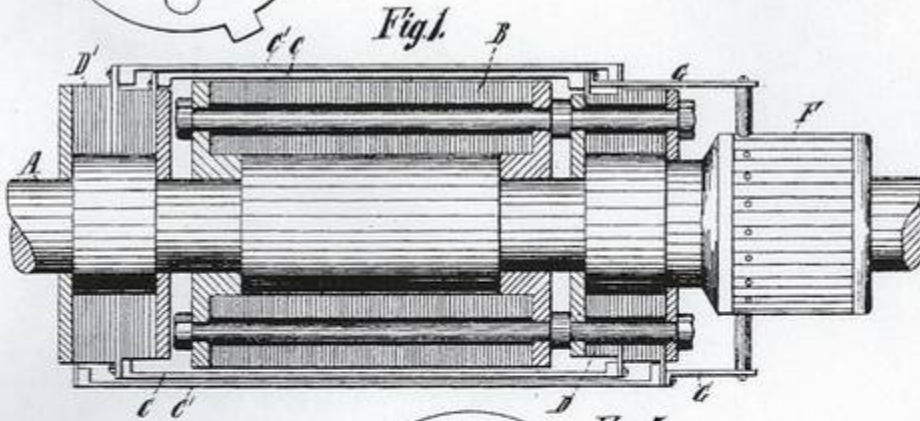
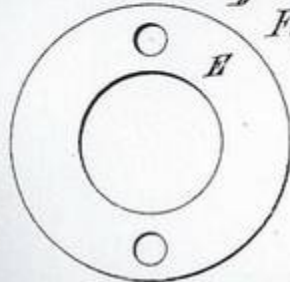

Fig. 5.



WITNESSES:

D. D. Mott  
Thomas C. Birch

INVENTOR:

T. A. Edison  
BY  
Dyer & Miller  
ATTORNEYS.

(No Model.)

2 Sheets—Sheet 1.

T. A. EDISON.

APPARATUS FOR TRANSLATING ELECTRIC CURRENTS FROM HIGH TO  
LOW TENSION.

No. 278,418.

Patented May 29, 1883.

Fig. 1.

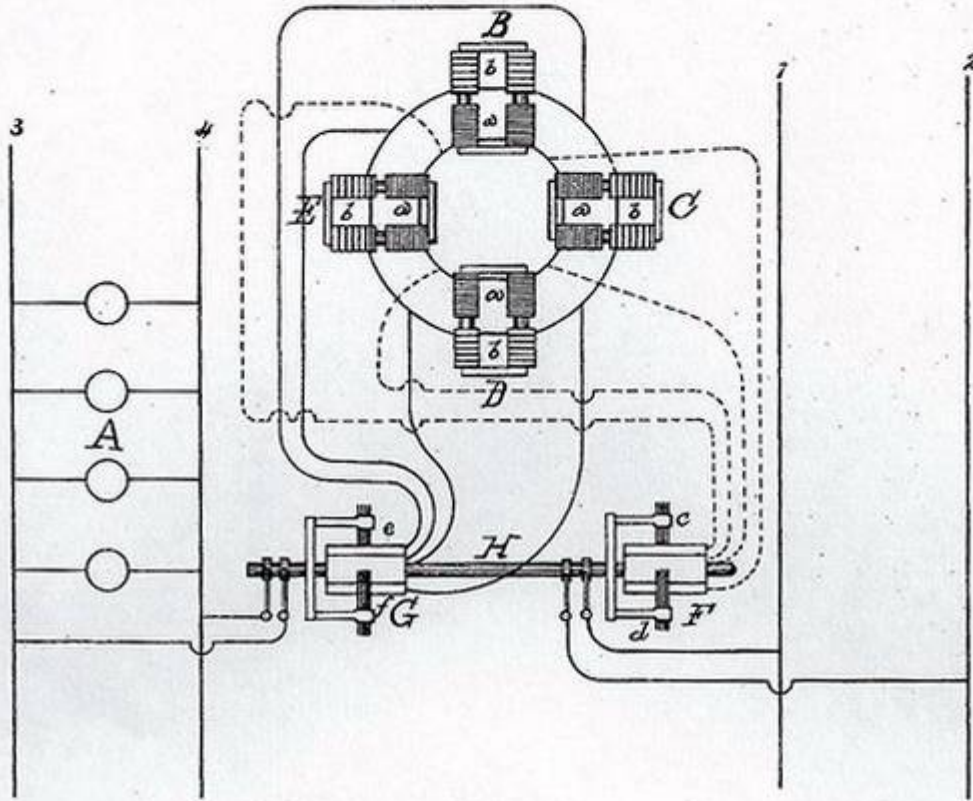

WITNESSES:

E. C. Rowlands  
W. S. Searcy

INVENTOR:

Thomas A. Edison,  
By Rich<sup>d</sup>. A. Dyer,  
Atty.

(No Model.)

G. WESTINGHOUSE, Jr.

SYSTEM OF ELECTRICAL DISTRIBUTION.

No. 373,035.

Patented Nov. 8, 1887.

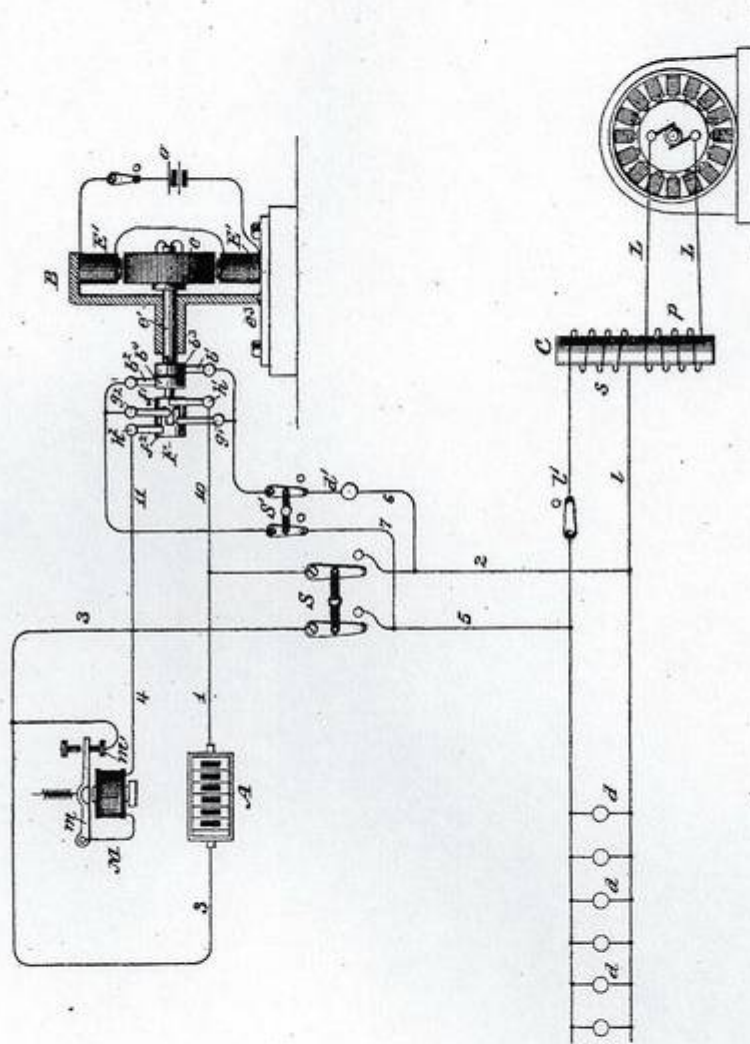

Witnesses

*Geo. W. Breck*  
*Carrie C. Ashley*

Inventor

*George Westinghouse, Jr.*

By his Attorneys

*Robert Edgecomb*



(No Model.)

G. WESTINGHOUSE, Jr.  
ELECTRICAL CONVERTER.

No. 366,362.

Patented July 12, 1887.

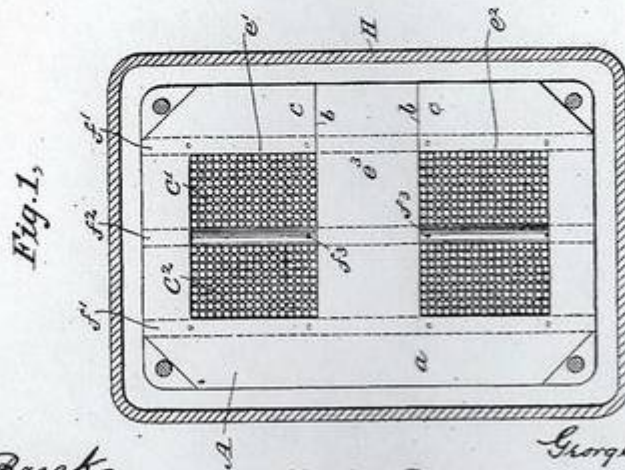
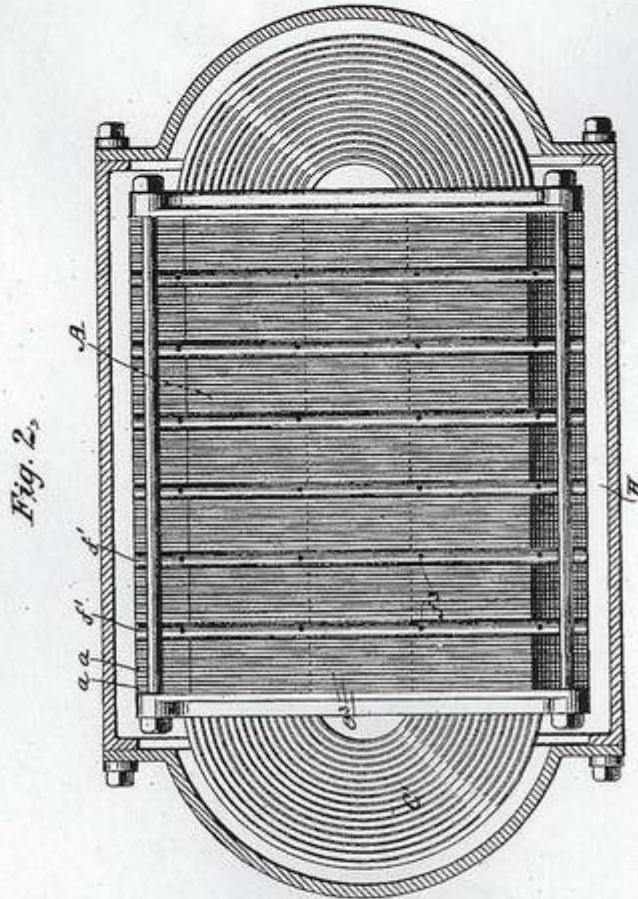

Witnesses  
*Geo. W. Brock,*  
*Carrie C. Ashley*

Inventor  
*George Westinghouse Jr.*  
By his Attorneys  
*Peper & Englecomb*

(No Model.)

2 Sheets—Sheet 1.

N. TESLA.

ELECTRICAL TRANSMISSION OF POWER.

No. 382,281.

Patented May 1, 1888.

*Fig. 1*

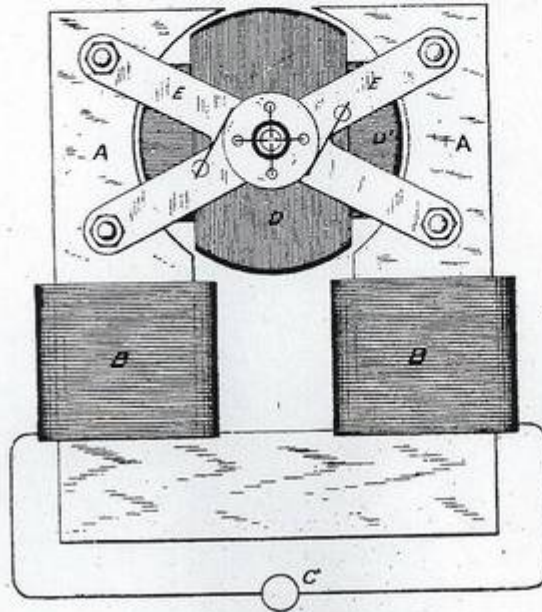

*Fig. 2*

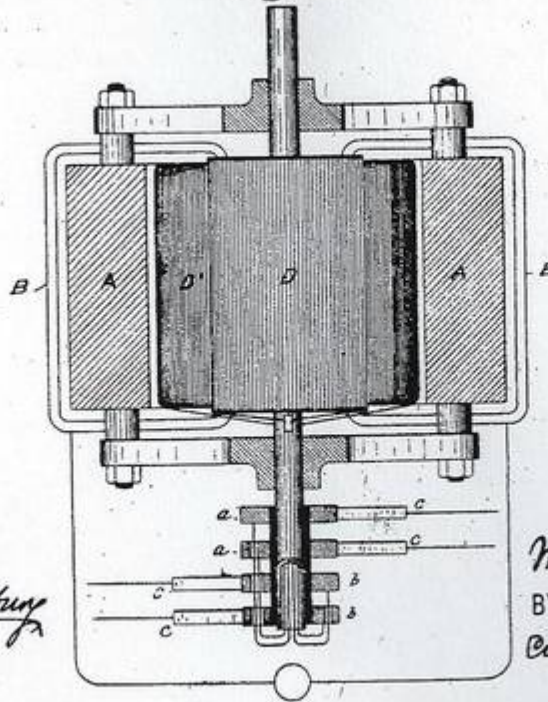

WITNESSES:  
*Raphael Mitter*  
*Henry F. Newbury*

INVENTOR.  
*Nikola Tesla.*  
BY *Duncan,*  
*Curtis & Page.*  
ATTORNEYS.



(No Model.)

2 Sheets—Sheet 1.

N. TESLA.

METHOD OF CONVERTING AND DISTRIBUTING ELECTRIC CURRENTS.

No. 382,282.

Patented May 1, 1888.

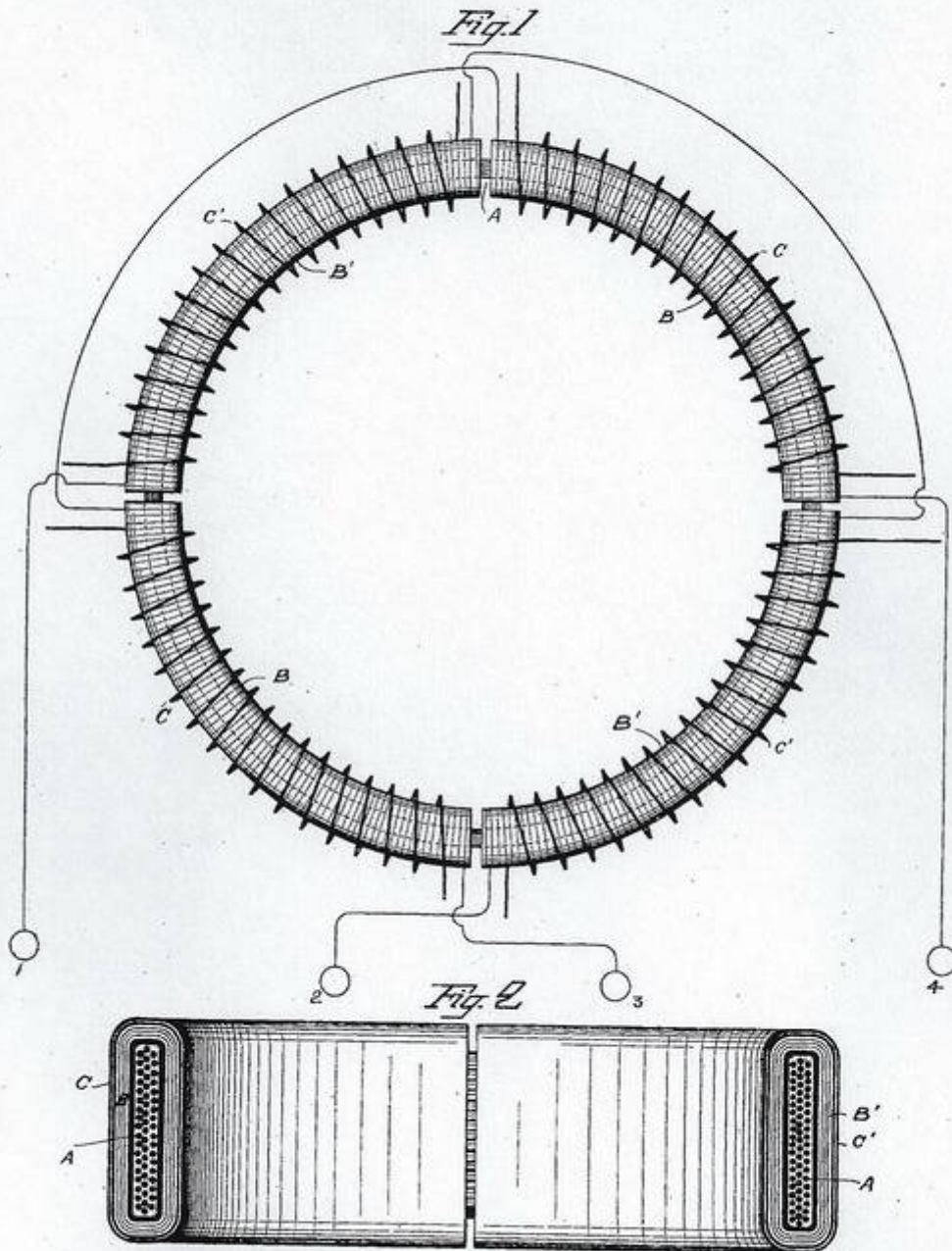

WITNESSES:  
*Raphael Netter*  
*Frank B. Mumphy*

INVENTOR,  
*Nikola Tesla*  
BY  
*Duncan, Curtis & Sage*  
ATTORNEYS.



(No Model.)

N. TESLA.

ALTERNATING CURRENT ELECTRO MAGNETIC MOTOR.

No. 433,700.

Patented Aug. 5, 1890.

Fig. 1

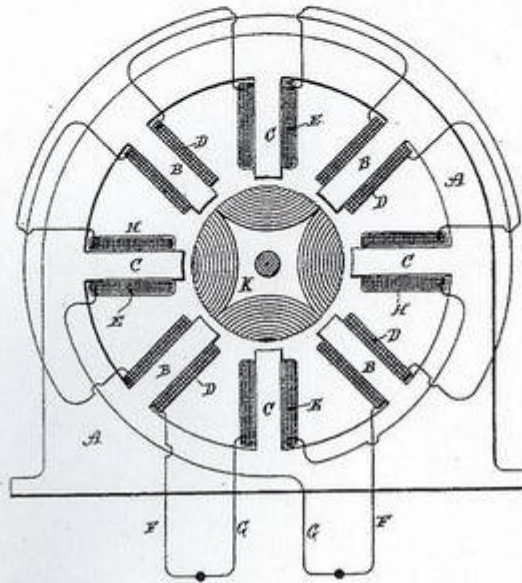
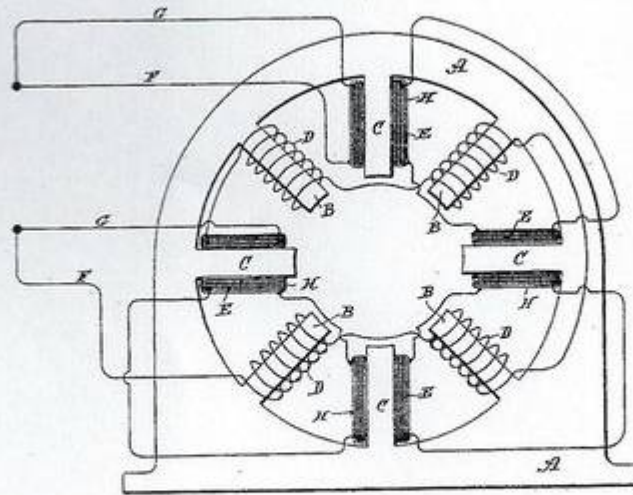

Fig. 2



Witnesses:

Raphael Netter  
Ernest Hopkinson

Inventor

Nikola Tesla  
by  
Dureau, Curtis & Sage  
Attorneys.