

REPLICA COPY



A.D. 1840 N° 8547.

Apparatus for Heating Apartments and Cooking.

PROSSER & RIPPONS' SPECIFICATION.

TO ALL TO WHOM THESE PRESENTS SHALL COME, we, RICHARD PROSSER, of Birmingham, in the County of Warwick, Civil Engineer, and JOHN JAMES RIPPON, of Wells Street, in the County of Middlesex, Ironmonger, send greeting.

5 WHEREAS we did, by Petition, humbly represent unto Her present most Excellent Majesty Queen Victoria, that, after considerable application and expence, we had invented "CERTAIN IMPROVEMENTS IN APPARATUS FOR HEATING APARTMENTS, AND IN APPARATUS FOR COOKING," and Her said Majesty, being willing to give encouragements to all arts and inventions which may be for
10 the public good, was graciously pleased, by Her Royal Letters Patent under the Great Seal of the United Kingdom of Great Britain and Ireland, bearing date at Westminster, the Seventeenth day of June, One thousand eight hundred and forty, in the third year of Her reign, for Herself, Her heirs and successors, to give and grant unto us, the said Richard Prosser and
15 John James Rippon, our eñors, adñors, and assigns, Her especial licence, full power, sole privilege and authority, that we, by ourselves, or by our deputies, servants or agents, or such others as we should agree with (and no others), during the term of fourteen years from the date of the said Letters Patent, should and lawfully might make, use, exercise, and vend our said
20 Invention within that part of Her said Majesty's Dominions called England, Her Dominion of Wales, and Town of Berwick-upon-Tweed, and also in all Her Majesty's Colonies and Plantations abroad, in such manner as to us, our eñors, adñors, and assigns shall seem meet, and as that we or they

Prosser & Rippon's Improvements in Heating Apartments and Cooking.

shall enjoy the whole profit and advantage arising by reason of the said Invention during the said term of fourteen years; and for that end Her said Majesty requires and strictly commands all Her subjects whatsoever, within England, Wales, and Berwick-upon-Tweed, and also in the Colonies and Plantations aforesaid, that they shall not, neither directly or indirectly, make, 5 use, or put in practice our said Invention or any part thereof, nor in anywise counterfeit, imitate, or resemble the same; nor make any addition thereto or subtraction therefrom, whereby to pretend himself or themselves to be the inventor or inventors thereof; and whereas the said Letters Patent also contain a proviso obliging us, the said Richard Prosser and John James Rippon, 10 particularly to describe and ascertain the nature of our said Invention, and in what manner the same is to be performed, by an instrument in writing under our hands and seals, and to cause the same to be enrolled in Her Majesty's High Court of Chancery within six calendar months next and immediately after the date of the said in part recited Letters Patent, as 15 in and by the same (reference being thereunto had) will more fully and at large appear.

NOW KNOW YE, that in compliance with the said proviso, we, the said Richard Prosser and John James Rippon, do hereby declare that our said Invention is described and ascertained in manner following, and by the aid 20 of the Fourteen Sheets of Drawings hereunto annexed, (that is to say):—

Sheet 1, Figures 1 and 2, shews one of our improved stoves called the Patent Vesta Stove, Figure 1 being a front elevation, and Figure 2 a side elevation of the same.

Sheet 2, Figures 1 and 2, shews the internal construction of the stove on 25 Sheet 1.

Sheet 3, Figures 1 to 6, shews the methods of constructing the firepot, and the arrangement for the admission of fuel into it without allowing dust or smoke to enter the apartment in which the stove is situated. The method of accomplishing this will be seen when we come to describe our improved fuel 30 hod, shewn on Sheet 13, Figures 1 to 4.

Sheet 4, Figures 1 to 6, contains delineation of part of stove; Figure 1 being an elevation of the moveable top of the stove (shewn on Sheet 1); Figure 2 a section through the same; Figure 3 a plan of the moveable top inverted; Figures 4, 5, and 6, different views of the drawer for containing 35 the ashes which are produced by combustion when the stove is in use.

Sheet 5, Figures 1 to 4, are delineations of parts the more clearly to show the construction and principle; Figure 1 being a plan; Figure 2, a sectional plan through the line *a, a* (on Sheet 2); Figure 3, a sectional plan through

Prosser & Rippon's Improvements in Heating Apartments and Cooking.

the line *b, b* (on Sheet 2); and Figure 4 a plan through the line *c, c*, on Drawing Figure 1, Sheet 2.

Sheet 6, Figures 1 to 4, are delineations in plans and elevations of the sliding plate and rakers.

5. Sheets 1 to 6 relate to one method of constructing our improved apparatus for heating apartments, which will be best understood by examining Sheet 2 and the explanations thereon. The firepot which contains the fuel is provided on its top with a slide or valve, shewn on Sheets 2 and 3. The fuel is admitted to the firepot through an aperture formed by opening this slide, and the smoke is prevented from passing directly out of the firepot by closing the slide; it then passes into the smoke pipe, and thence to a chimney, as indicated by the arrows, no smoke or fire being in contact with the external surface of the stove. The fuel is supported on a grate near the bottom of the firepot, Figures 1 and 2, Sheet 2. Between the bars of the grate rakers are introduced for the purpose of agitating the fuel, and causing the ashes to fall into a receiver. The rakers are rivetted to a sliding plate, which forms the bottom of the receiver for ashes. The sliding plate and rakers are moved simultaneously by pulling the handle A, Sheet 2. When the handle A is drawn out the ashes and cinders which reposed on it fall into the drawer beneath, and may then be carried away. If the sliding plate is not pushed back by the handle A, the atmospheric air would enter through the opening thus formed (in the bottom of the receiver for ashes), and the fire would burn too briskly and waste the fuel. This sliding plate should therefore be pushed in so as to close the aperture, and the air required to support combustion admitted through a regulated aperture, shewn Figure 2, Sheet 1, and Figure 3, Sheet 5. The sliding plate has another use besides those of moving the rakers, and allowing the ashes to fall into the drawer beneath. When the fire requires lighting the sliding plate is drawn out, and the combustibles on the top of the grate are lighted through this opening, which admits a light to the under side of the fire grate; the sliding plate is left open until the fire is burned up; the sliding plate is then pushed in and air admitted above the sliding plate and below the line *b, b*, Figure 1, Sheet 2, through the regulated aperture before described. The sand between the lines *a, a*, and *b, b*, Figure 1, Sheet 2, is for the purpose of preventing atmospheric air finding its way into the chimney except through the fire grate, and the sand rim near the top prevents the emission of smoke into the apartment:

Sheet 7, Figures 1 and 2, are sections of a stove on the same principle as the one before described. In this stove the smoke is allowed to come in contact with the external case before it gets into the chimney (but the fuel is not

Prosser & Rippon's Improvements in Heating Apartments and Cooking.

allowed to touch the external case, and plays round the firepot in a space between the lines *a, a,* and *b, b,* Figures 1 and 2, Sheet 7. Sand is placed upon the diaphragms *a, a,* and *b, b,* and for a similar purpose, as before described when treating of the stove, shewn on Sheets 1 to 6. The rakes, the sliding valve or plate, and the ash drawer are similar in their use to those 5 before described.

Sheet 8, Figure 1, is an elevation of a stove having two smoke pipes; Figure 2, a sectional plan through the line *a, a,* Figure 1; and Figure 3 a section through the upper part of Figure 1 shewing the sliding valve covering the top 10 of the firepot to prevent the emission of smoke, and serving also as a bottom to the reservoir for fuel. When the valve is drawn out, the fuel above it falls into the firepot, and the moveable top being on the stove when the valve is drawn prevents the emission of smoke into the apartment.

Sheet 9, Figure 1, shews a section of a stove with two smoke pipes, the upper one being used in those situations where chimneys have a bad draught 15 and the lower one where chimneys have a good draught. The stove here referred to has no damper or sliding plate to cover the top of the firepot or the bottom of the fuel reservoir; it will, therefore, be apparent, that, during the time of feeding the stove with fuel, smoke or vapour will be admitted into the apartment, as is the case in stoves now in use. The construction of this 20 stove will be apparent from an examination of the Drawings on Sheet 9, and comparison with Sheets 1 to 8.

Sheet 10 shews the method of constructing a stove suitable for forcing-houses. It consists of a stove similar to that shewn on Sheet 7, with the addition of an external case which surrounds the stove, and leaves a 25 space or interval between the two. This space is supplied with air from the outside of the house through the pipe *a,* Figures 1 and 5. The air becomes heated by contact with the case of the stove, and ascends to the upper part of the external case, when it branches off to the parts requiring warmth. In the stoves shewn on Sheet 10 two pipes are used, but the number of pipes 30 will vary with the requirements of the stove. The warm air is conveyed by the tubes or pipes to its required destination; and to prevent the air being too hot, which passes from the pipe into the apartment, the pipes pass through reservoirs containing water which surrounds the pipe. These reservoirs for water are placed at intervals along the pipes, and holes are bored in the pipe, between 35 the reservoirs for the emission of warm air into the apartments. The holes may be so regulated as to emit any quantity of the air contained in the pipes into the apartment; or by closing the holes in the pipes the air will be compelled to find its exit at the far end of such pipe, or through those holes which are left.

Prosser & Rippon's Improvements in Heating Apartments and Cooking.

open. The passage of the hot air contained in the pipes through the reservoirs containing water will evaporate some of the water; and while the heated air is reduced in temperature, so as to prevent injury to vegetation, any degree of moisture is communicated to the air of the house, which in some horticultural operations seems not only desirable, but necessary for their existence.

Sheet 11 shews the construction of firepot used in the stove, Figures 4 and 5, Sheet 12, where the construction of the stove is shewn. Figure 4 is a sectional elevation of a stove where the envelope or case must be removed in order to supply the fire with fuel. Figure 5 is a plan of the same stove through the line *a, a*, Figure 4, Sheet 12. On an examination of these Figures 4 and 5, it will be seen that the smoke does not come in contact with the outside case of the stove, but is conducted from the firepot into the chimney, as indicated by the arrows. In this construction of stove the rakers are moved independently of the valve or sliding plate which closes the hole through which the fire is lighted. Upon the end of the rod which moves the rakers, and at right angles to it, a plate of iron is fixed; and when the rod is pushed in this plate stops the orifice *b* leading to the chimney. The use of this orifice is to allow the dust caused by the rakers to pass into the chimney, instead of being allowed to enter the apartment. The rod which moves the rakers passes down the centre of the air pipe, and the rakers are situated between the firebars of the grate, as before described, for the purpose of clearing the bars or fuel of ashes. Any dust arising from the use of the raker or the valve under the rakers will pass through the hole *b* into the chimney, provided the air regulator is placed open to allow a current of air to enter through the same, and pass through the hole *b* into the chimney. The firepot of the stove, Figures 4 and 5, Sheet 12, is furnished with a cover fitting smoke-tight into a sand rim for the purpose of forcing the smoke to descend, as shewn by arrows in Figure 4:

Sheet 12, Figures 1, 2, and 3, shews our improvements in apparatus for cooking, which apparatus consists of a rectangular iron box, in the inside of which is a portable firepot or firepots. The construction of the firepot is shewn at Figure 3, *a* and *b*, Sheet 12, *b, b*, being apertures to allow of the ashes being removed; air is supplied to the fuel at *c*, and the smoke or other vapours of combustion escape at *d* into a chimney. The top of the box becomes heated by the internal fires, and forms a hot plate, upon which the operation of cookery may be carried on. *e*, Figure 1, is a cubical or other formed cover, under which roasting may be performed. This cover has no bottom, it merely serves to keep in the heat and surround on all sides (except

Prosser & Rippon's Improvements in Heating Apartments and Cooking.

the lower) the article which requires roasting. The ring shewn, Figure 2, *a, b*, serves to support any vessel used in cooking which has a round or concave form of bottom, so as to retain the same firmly on the hot plate formed by the top of the box before described.

Sheet 13 shews the coal or fuel hod, the constitution of which will be understood by examining Figures 1, 2, 3, and 4, and the references thereon. It is used in the following manner:—The hod or feeder is charged with fuel through the aperture formed in the top by drawing out the slide; when it is filled with fuel the slide is pushed in, and the hod is inverted and carried by the handle; *a*, the slide, now forming the bottom of the hod upon which the fuel rests. 10 There are two holes in the slide, one for the insertion of the fingers in order to move the slide, and another a rectangular slit *b* which fits on to the projecting piece *z* of the sliding valve on the top of the firepot, Figure 1.

Sheet 7; Figure 2, Sheet 2, and Figures 2, 3, 4, 5, and 6, Sheet 3. The fuel hod or holder is placed on the top of the firepot, the projecting piece *z* 15 fitting into the rectangular slit in the valve or slide. On drawing the slide of the fuel hod or holder, the slide on the top of the firepot is drawn with it, and the fuel falls into the firepot. On pushing the handle back both slides move again together, and the holes in the top of the firepot and in the bottom of the fuel hod become closed. The fuel hod is removed from the top of the firepot, 20 and the moveable top is placed in its proper situation on the stove. In this operation any smoke or dust which arises passes into the fuel hod or feeder, and is carried away; none passes into the apartment, because the slide on the top of the firepot is never opened except when the fuel hod is in its proper position.

To avoid claiming or appearing to claim any portion of the Invention of a peculiarly constructed stove or apparatus for heating apartments for which Letters Patent were granted unto Mr. Richard Prosser, of Birmingham, Civil Engineer, on or about the Seventeenth day of February, One thousand eight hundred and thirty-nine, we commence this part of our Specification by craving 30 reference to said Letters Patent, and we call attention particularly to three essential parts of the Invention for which he has obtained Letters Patent, namely,

The base or stand of his stove;

Secondly, the moveable envelope or case with a moveable top, in order (as his stove has no door) to replenish the fire and remove dust and ashes; and, 35

Thirdly, the furnace or firepot so constructed as to prevent any part of the fuel from being in contact with the envelope, which is placed at such a distance from the fuel as to prevent its being over-heated.

We refer to the said Letters Patent, that we may more clearly point out in this.

Prosser & Rippon's Improvements in Heating Apartments and Cooking.

our Specification what we claim as our Invention in contradistinction to what has been already claimed and patented by Mr. Prosser. The base of his stove is a circular plate of cast iron standing on three feet, with three concentric rings on its upper surface, having an aperture in the centre with a valve adjusted to
5 such aperture to regulate the admission of the external air, and a tube or flue for the escape of the gases of combustion.

The improvements which we claim in this construction of the base or stand are the following:—We make our stand (of which a Drawing marked Z is annexed) the top or cover of a hollow box of any convenient size or shape, and
10 when we wish to make the gases of combustion descend, we divide the internal part of the box by a partition, so as to cause the air which supports combustion to enter on one side of the partition Y, and the gases of combustion to pass out on the other 2 into the flue 3, through which they escape into the atmosphere.

15 Drawings, marked Y, of circular, square, and hexagonal hollow boxes are annexed, to shew not only how they are divided, but also that they may be made of any size or shape that it may be thought desirable to give to the stand or base of the stove. We controul the admission of the external air which supports combustion in our stove by two or more
20 regulators or dampers, one of which we place over the fire bars, and the other under them. Either or both of our dampers may be used at pleasure, so that, while the under one is employed in regulating the proper supply of atmospheric air under the fire bars, the upper one may be used for moving the fuel, and freeing it and the fire bars from dust and ashes. Both of our
25 regulators should be opened when it is desirable to expose the fuel to a full and free draft of air from below, and both should be shut when it is wished to cut off all communication with the air below the fire bars more effectually than could be done by closing only one of the regulators. Our fire bars are not fastened to the vessel which holds the fuel, but are inserted (see Figure Z, 4.)
30 in the stand which forms the top of the hollow box already described, and which box may be made of metal, or of well-prepared porcelain or plastic clay. A drawer of metal may be placed in that portion of the box 1 which is under the fire bars 4, but it will be found that a neatly-fitted earthen or porcelain pan will answer equally well in our stoves if the top of the pan be placed lower
35 than either of the dampers which regulate the supply of external air to the fuel. That part of our stove which contains the fuel may be made of metal, or of refractory stone or fire clay. The form of the lower part of it may be varied at pleasure to suit different tastes and fancies; so that care be taken to adjust it accurately to the stand which supports it; but as we consider the
40 cylindrical form one of the most easily understood, and most convenient and

Prosser & Rippon's Improvements in Heating Apartments and Cooking.

beautiful, we proceed to describe our improvements in stoves of that shape, from which description stoves which have any other shape may, mutatis mutandis, be readily be manufactured.

Figure X is a vertical section through the centre of the cylinder containing the fuel, and having a pipe 5 in its top to carry off the gases of combustion; 5 the bottom of the cylinder is open, and must be adjusted on the stand over the fire bars. In the side of the cylinder we leave an aperture or apertures, varying in size and shape according to the greater or less surface of fuel that we may wish to expose occasionally to the open air, and to see during its combustion. Around the cylinder and under the aperture there is a ring or segments 10 forming brackets fastened, in which ring or brackets there is a groove of any required width and depth. Upon the inner cylinder we place a covering having any suitable plane or curve surface, or forming, if preferred, a section or segment of any suitable plane or curve surface, which covering, in order to avoid useless repetitions, we shall in this our Specification describe as another 15 cylinder, open at the bottom, whose lower edge rests in this groove, and whose top may be of any desired shape, and pierced so as to pass over the pipe 5 which is in the top of the inner cylinder X, or be adjusted to the inner cylinder in any other convenient manner; in the side of this outer cylinder we leave an aperture suitable in size and shape to the aperture in the side of the 20 inner cylinder, and so that it may be placed, when wanted, exactly opposite to it. The aperture in the side of the outer cylinder may be ornamented by varying its outline in any way, or by covering portions of it with open fancy work. The side of the outer cylinder may, if desired, have two or more apertures, one of which may be laticed, and the other open, but the side 25 of the inner cylinder need have but one aperture, through which the fire may be seen and replenished, unless it may be used for warming two or more contiguous rooms, and divided for that purpose. Figure W is a vertical section of the outer cylinder, having half the height of the inner cylinder X. Figure V is a vertical section of the outer cylinder having three fourths of 30 the height or length of the inner cylinder X. Figure T is a vertical section of the outer cylinder of such height as to cover the inner cylinder X entirely, and consequently to require no grooved belt or brackets for its support, which, in this last case, it derives from the stand upon which the inner cylinder itself is placed. In this last construction the flue for the escape of the 35 gases of combustion may be carried under the lower edge of the outer cylinder, as shewn in Figures Y, 2 and 3, unless it be taken through its top; and in all constructions of the stove where the flue of the gases of combustion is carried from the side of the inner cylinder X, it may be made to pass under the lower edge of the outer cylinder.

Prosser & Rippon's Improvements in Heating Apartments and Cooking.

From inspection of Figures W, V, and T, S, R, and Q, it will be at once obvious that the length or height of the outer cylinder, as well as the form and size of the aperture, may be made like its external appearance, to vary according to the taste of those who may construct the stove; and as the distance between the outer and inner cylinder may be modified at pleasure, the outer one may, if wanted, be made of metallic and other substances in various colours. The outer cylinders should have of course knobs or handles for turning it, and when only one aperture is wanted in it for seeing the fire, another may be cut of twice the diameter of the smoke pipe should it be required to place the smoke pipe in the side of the inner cylinder, without passing it under the bottom edge of the outer one. Although for ordinary purposes the side of the inner cylinder need have only one aperture, yet it may have, if wanted, two or more apertures of equal or different heights from the base. When apertures are not made near the base of the cylinder for removing the ashes, a hollow tube may form the centre of the moveable fire bars; the tube serves as a handle for removing the fire bars, and allowing the ashes to fall through the top of the stand into the pan or drawer placed below it. In Figure S the external and internal apertures are entirely open. In R, the external hexagonal aperture partly covers the internal one, and in Q a higher inner aperture of another form is also represented as partly closed. A third or fourth partial or entire covering, or any greater number, may be inter or super posed, and may be passed or not over the pipe 5, at the top of the internal cylinder X, with or without a grooved belt or brackets to support its bottom edge; but for ordinary purposes we find one inner and one outer cylinder quite sufficient, without interposing a third plane or curved surface.

We claim the above or any similar mode of constructing stoves as answering a twofold purpose. First, that of kindling and replenishing the fire without taking the case from off the base, or taking off the top, or any portion of the top of the case, as already done under Mr. Prosser's Letters Patent; and secondly, enabling persons to see an open fire whenever they wish it to shut off as much or as little of the open fire as they like, and to cause the outer case, whether made of metallic or other substances, to act either as a blower or as a close or open screen.

We sometimes make that part of our stove which holds the fuel of steatite and refractory fire clay. The employment of these and similar substances is well known and commonly practised; but we claim an improvement in the use of them which prevents any mischief from arising by reason of their cracking, and which we effect by interposing the steatite, fire clay, or other refractory substance between trellis-work of wire or perforated sheets of metal.

Prosser & Rippon's Improvements in Heating Apartments and Cooking.

Having by the foregoing description, and the aid of the Fourteen Sheets of Drawings hereunto annexed, and the writing thereon, described our "Improvements in Apparatus for Heating Apartments, and in Apparatus for Cooking," we now proceed to claim as of our Invention the construction of apparatus for heating apartments, where a sliding valve is placed over the fire, either for the purpose of admitting fuel or preventing the emission of smoke into the apartment.

We also claim as of our Invention the employment of a valve or damper moving on the top of the fire bars as before described, for the purpose of increasing or diminishing the effective area of the fire grate, and removing ashes or cinders therefrom.

We also claim the construction of apparatus for heating apartments, wherein rakers are employed as a part of such apparatus; either separate as shewn on Sheet 12 at Figure 4, or in combination with a sliding plate or damper, as shewn on Sheets 2, 6, and 7.

We also claim, as shewn on Sheets 1, 2, 7, 8, 9, & 12; the construction of apparatus for heating apartments where a sliding plate is employed under the fire bars to allow of a light being readily introduced under the fire bars for the purpose of igniting the combustibles placed thereon.

We claim the use of this sliding plate or valve for the above purpose separately or in combination with the rakers.

We claim the construction of apparatus for heating apartments shewn by Figures Z, Y, X, &c., on Sheet 14.

We claim also the apparatus for cooking shewn on Sheet 12, Figures 1, 2, and 3.

We also claim the feeding apparatus or fuel hod or holder shewn on Sheet 13, as part of our improved apparatus for heating apartments.

Having now described our improvements in apparatus for heating apartments, and apparatus for cooking, we claim the exclusive use of such improvements as are shewn in Sheets 1 to 14 of the Drawings hereunto annexed, and also to such variations of construction as may be made in apparatus for heating apartments, and in apparatus for cooking, without departing from the principle of our Invention; as described and ascertained by this our Specification.

In witness whereof, we, the said Richard Prosser and John James Rippon, have hereunto set our hands and seals, this Seventeenth day of December, One thousand eight hundred and forty.

RICHARD (L.S.) PROSSER.

JOHN JAMES (L.S.) RIPPON.

Prosser & Rippon's Improvements in Heating Apartments and Cooking.

AND BE IT REMEMBERED, that on the Seventeenth day of December, in the year of our Lord 1840, the aforesaid Richard Prosser and John James Rippon came before our said Lady the Queen in Her Chancery, and acknowledged the Specification aforesaid, and all and every thing therein 5 contained and specified, in form above written. And also the Specification aforesaid was stamped according to the tenor of the Statute made for that purpose.

Inrolled the Seventeenth day of December, in the year of our Lord One thousand eight hundred and forty.

LONDON :

Printed by GEORGE EDWARD EYRE and WILLIAM SPOTTISWOODE,
Printers to the Queen's most Excellent Majesty. 1857.

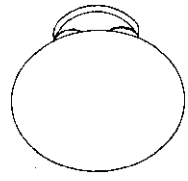

*ash
draw*

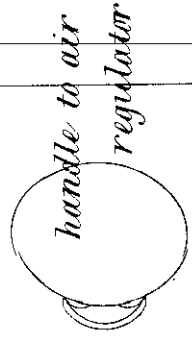
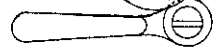

*handle to air
regulator*

ash draw

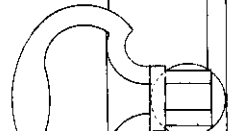

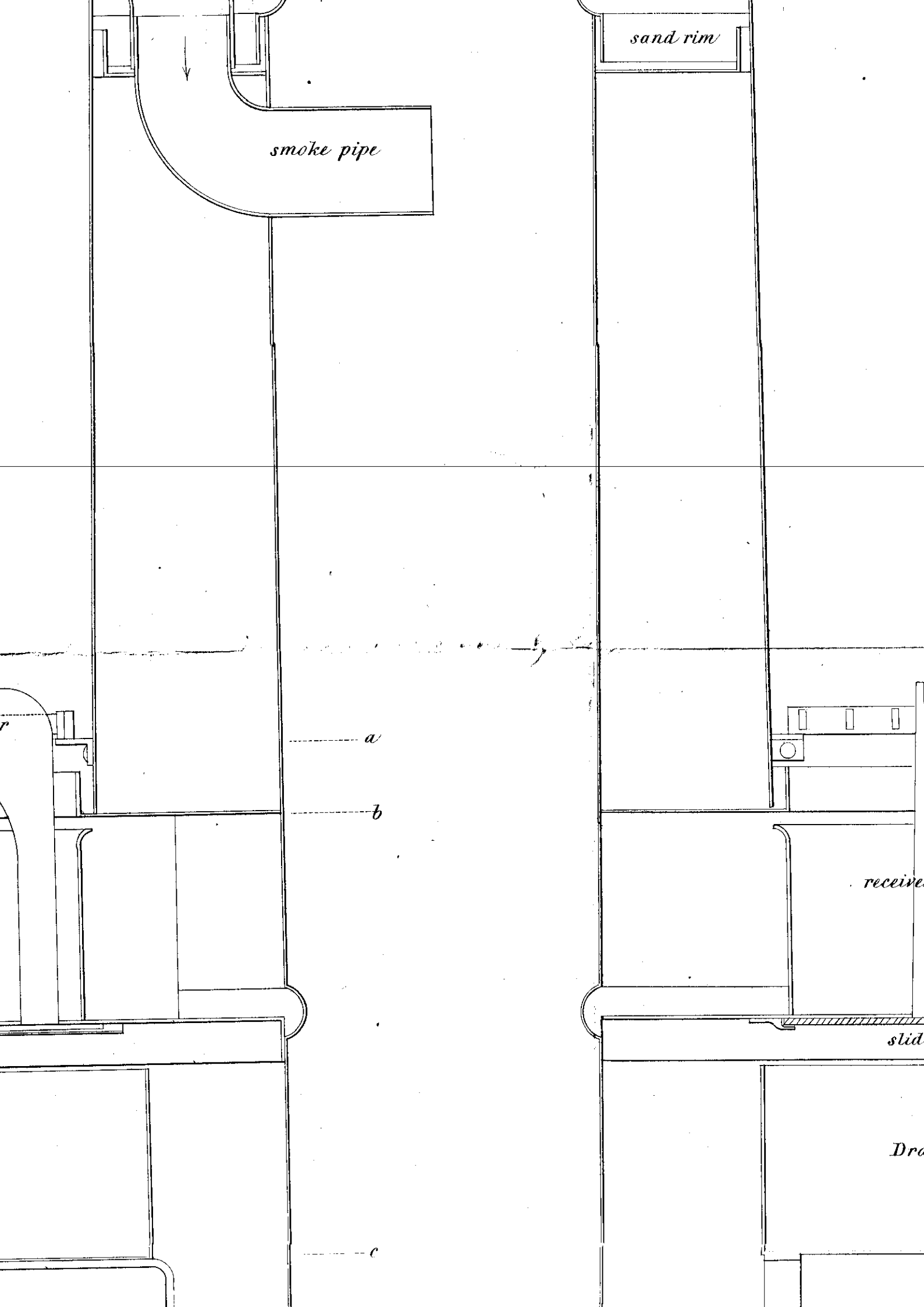

sand rim

smoke pipe

a

b

receive

slid

c

Dra

FIG. 3. Section of fire pot

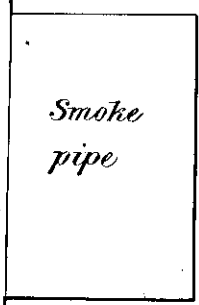
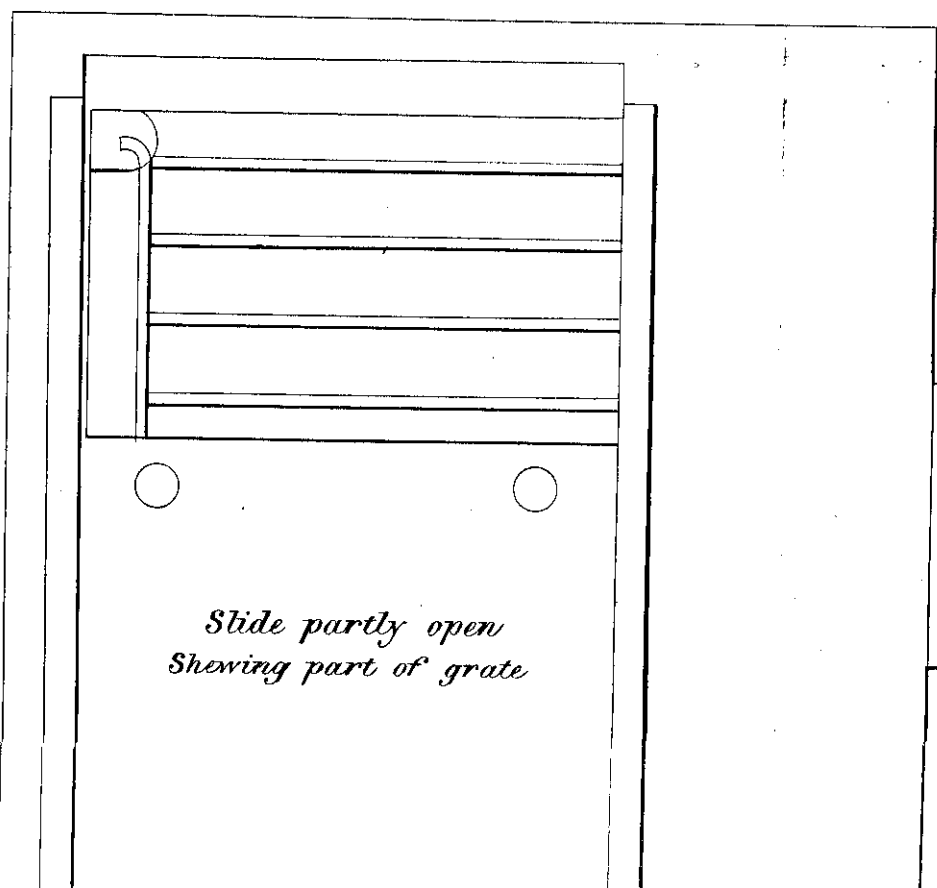
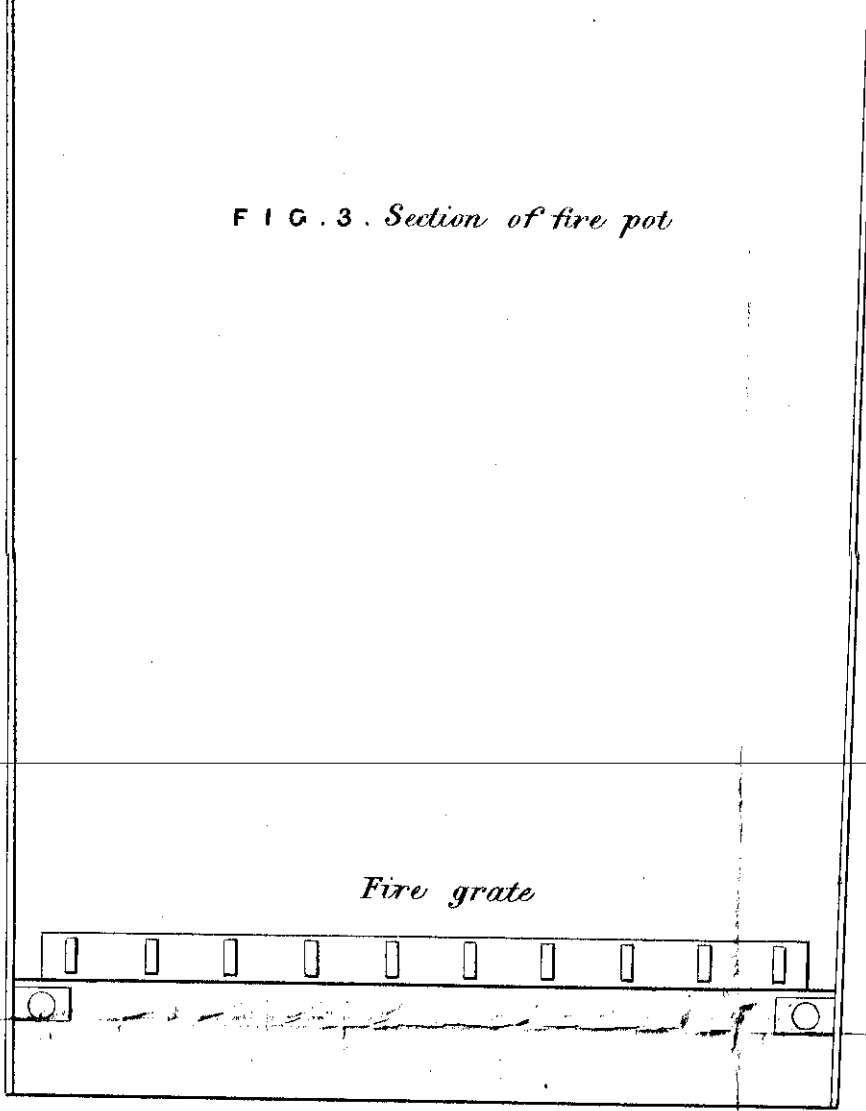

section through top of stove

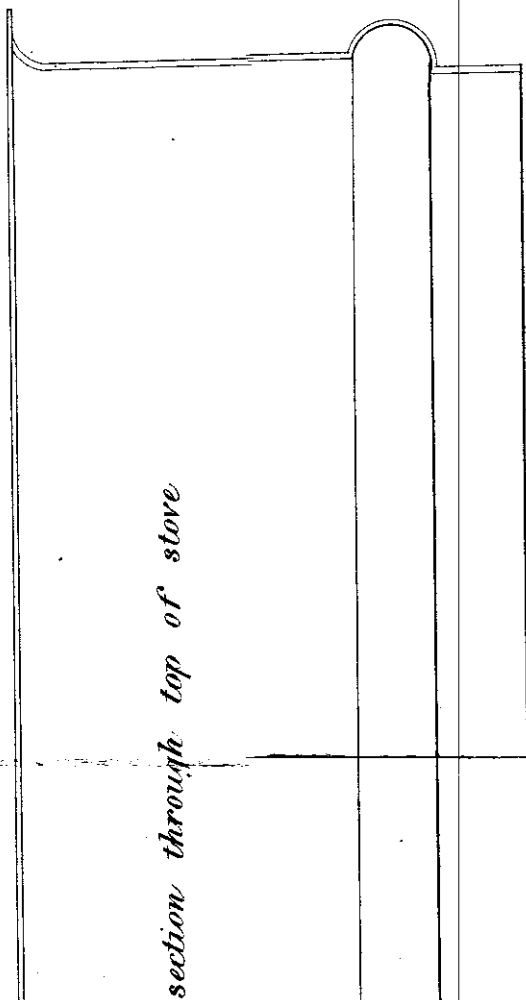

FIG. 5.

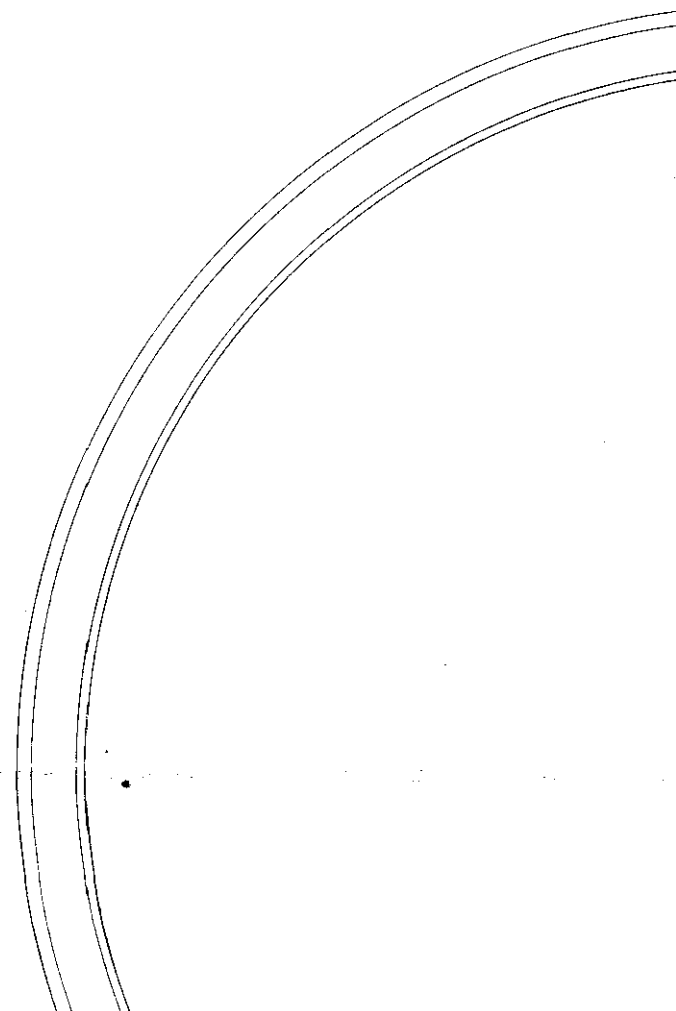
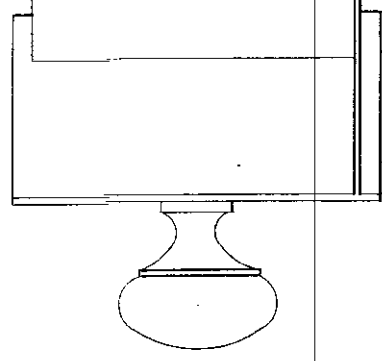
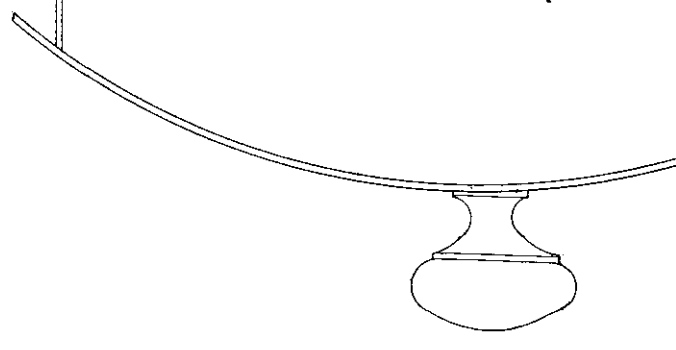

FIG. 6.



*entrance
to
smoke
pipe*

*smoke
pipe*



bar

FIG. 2.

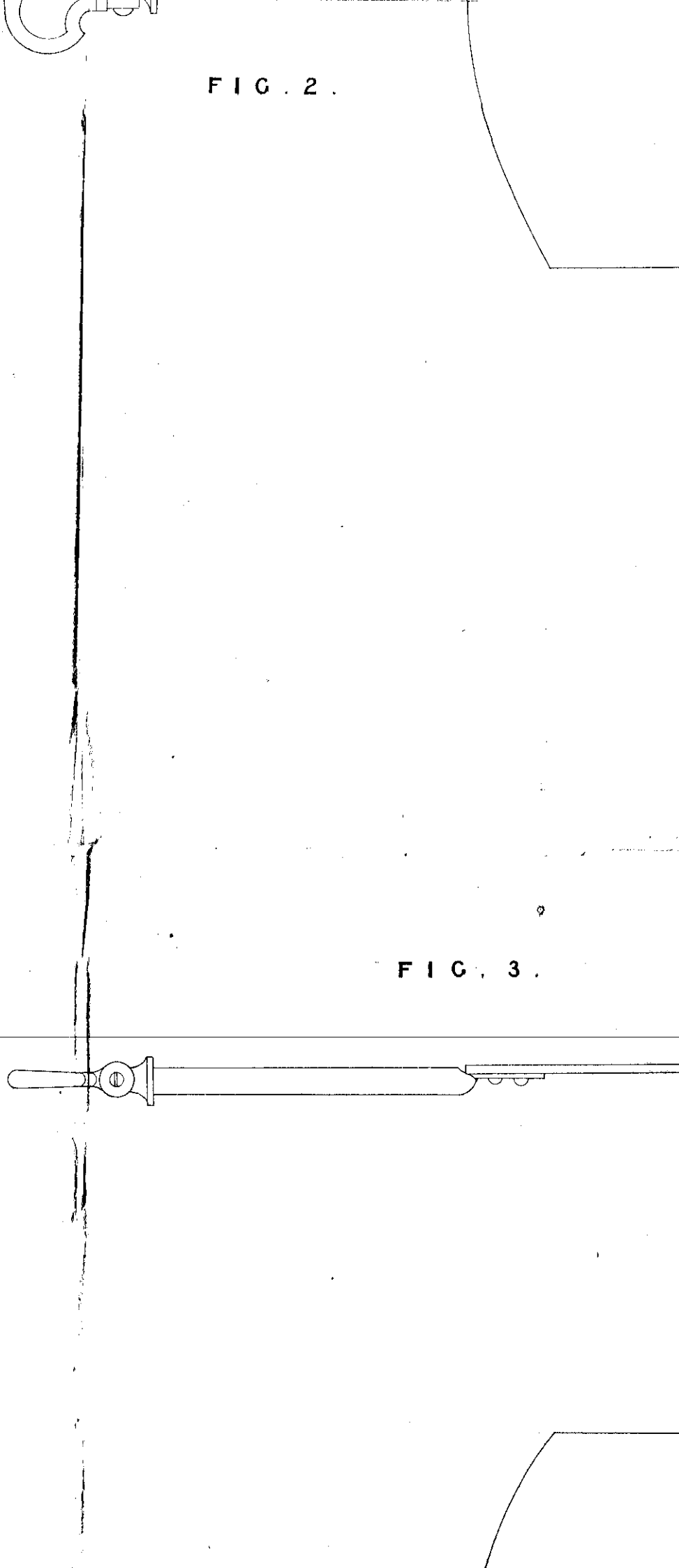

FIG. 1.

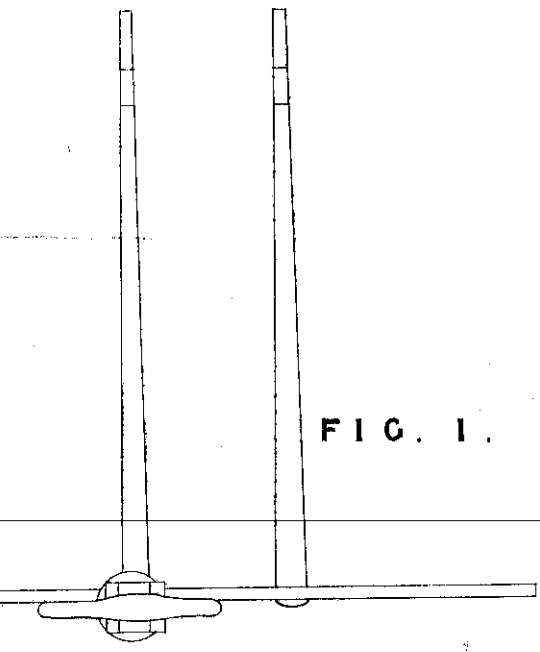
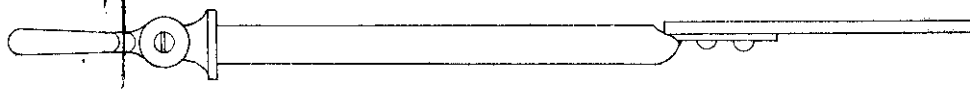

FIG. 3.



*chimney
pipe*



*Fire
bars*

b

Sliding



F I C H

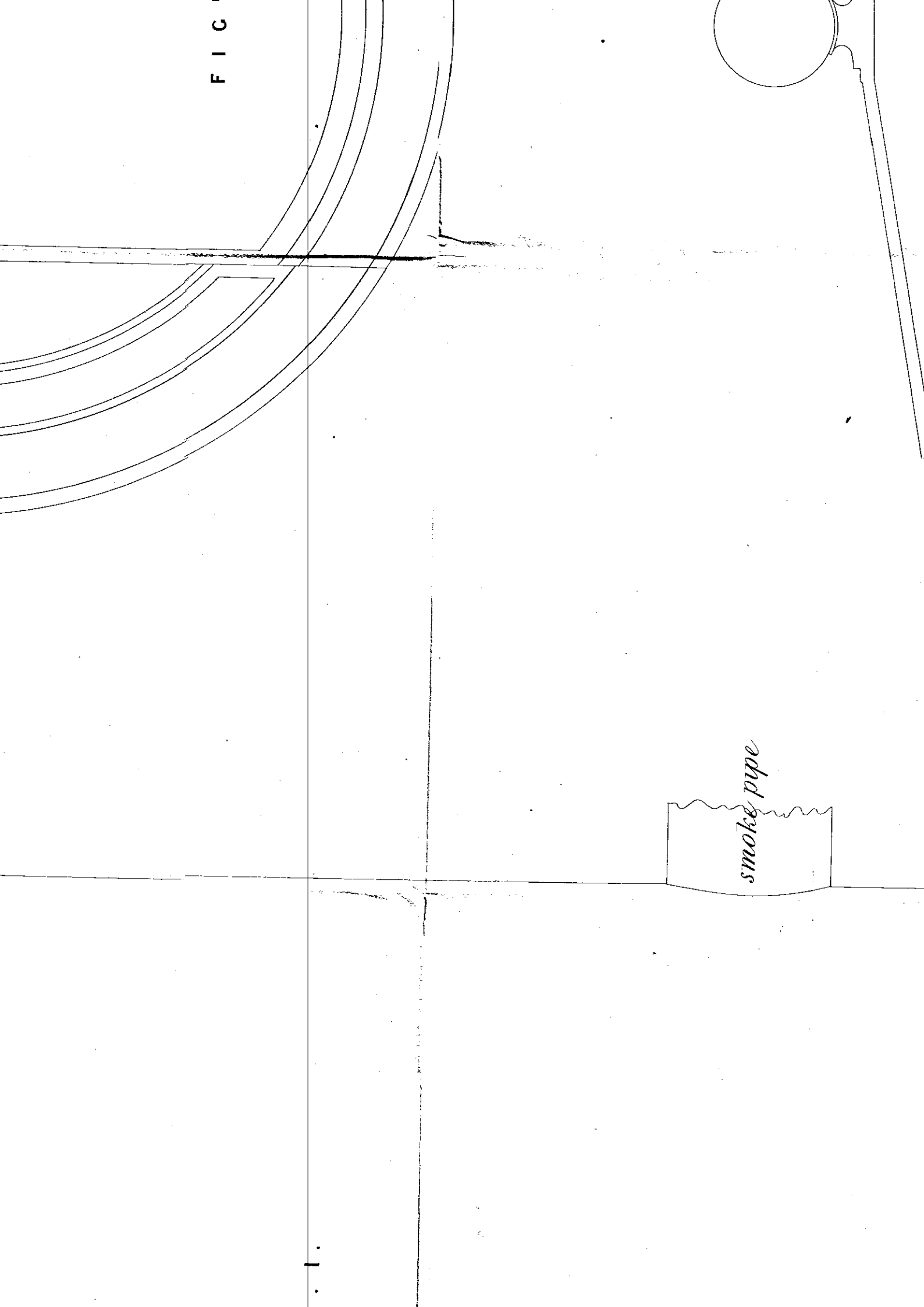

smoke pipe

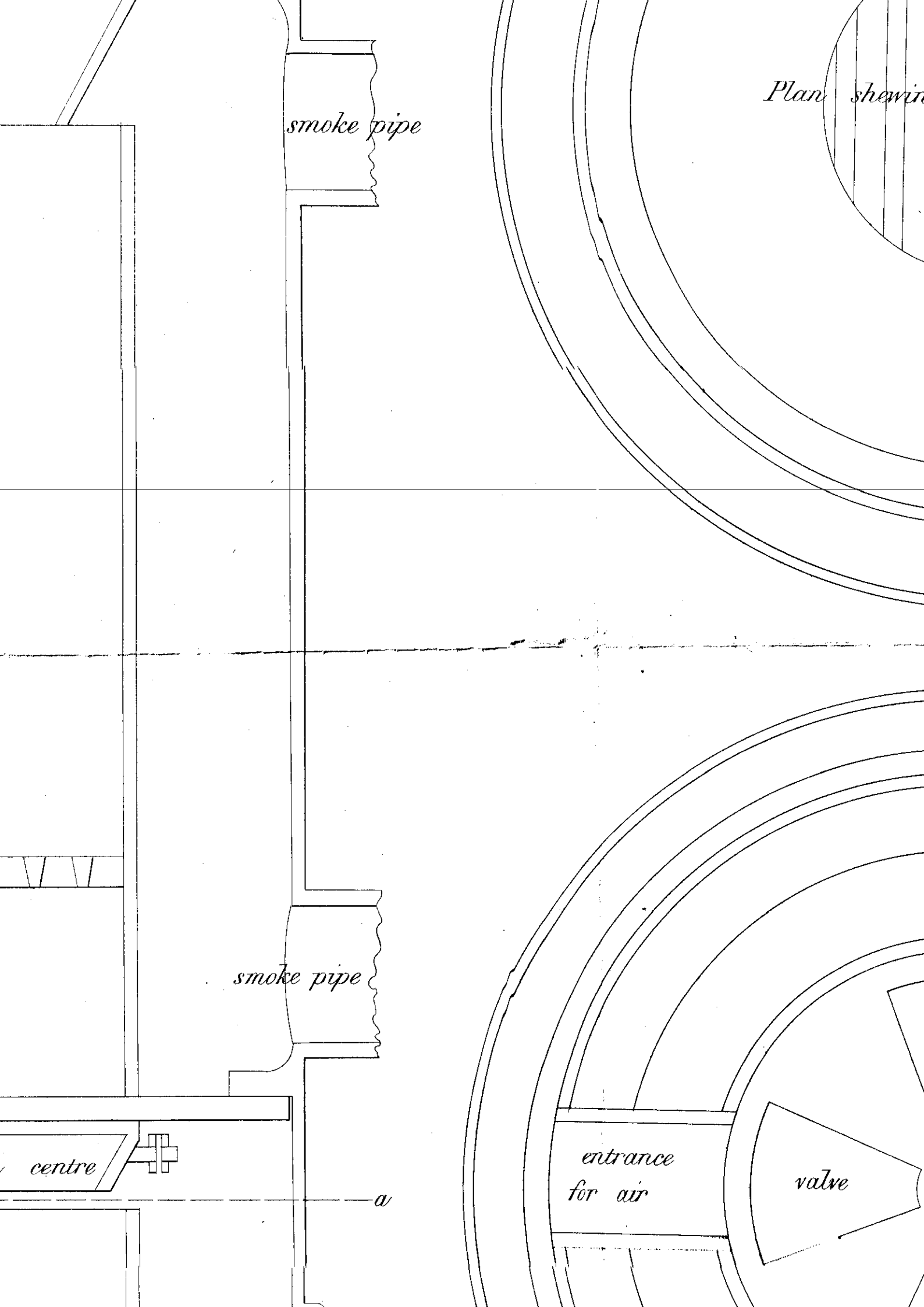

FIG. 2 Section

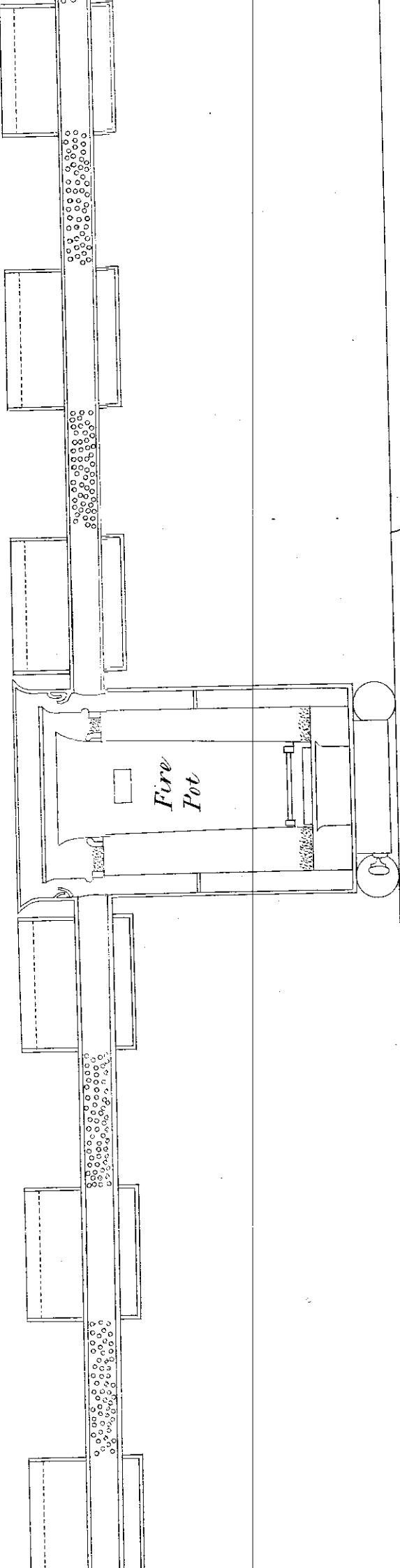
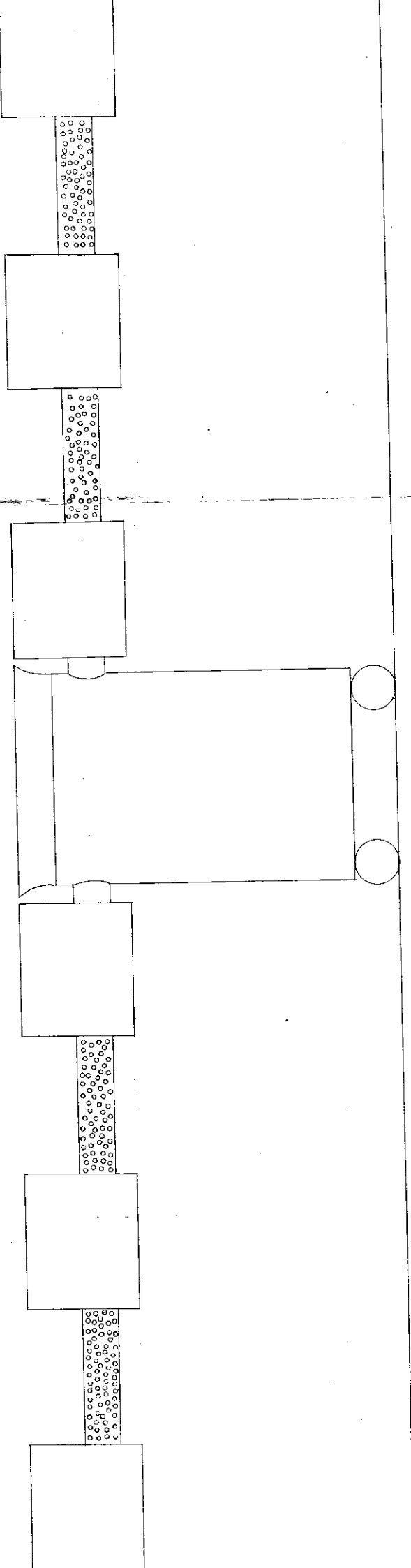
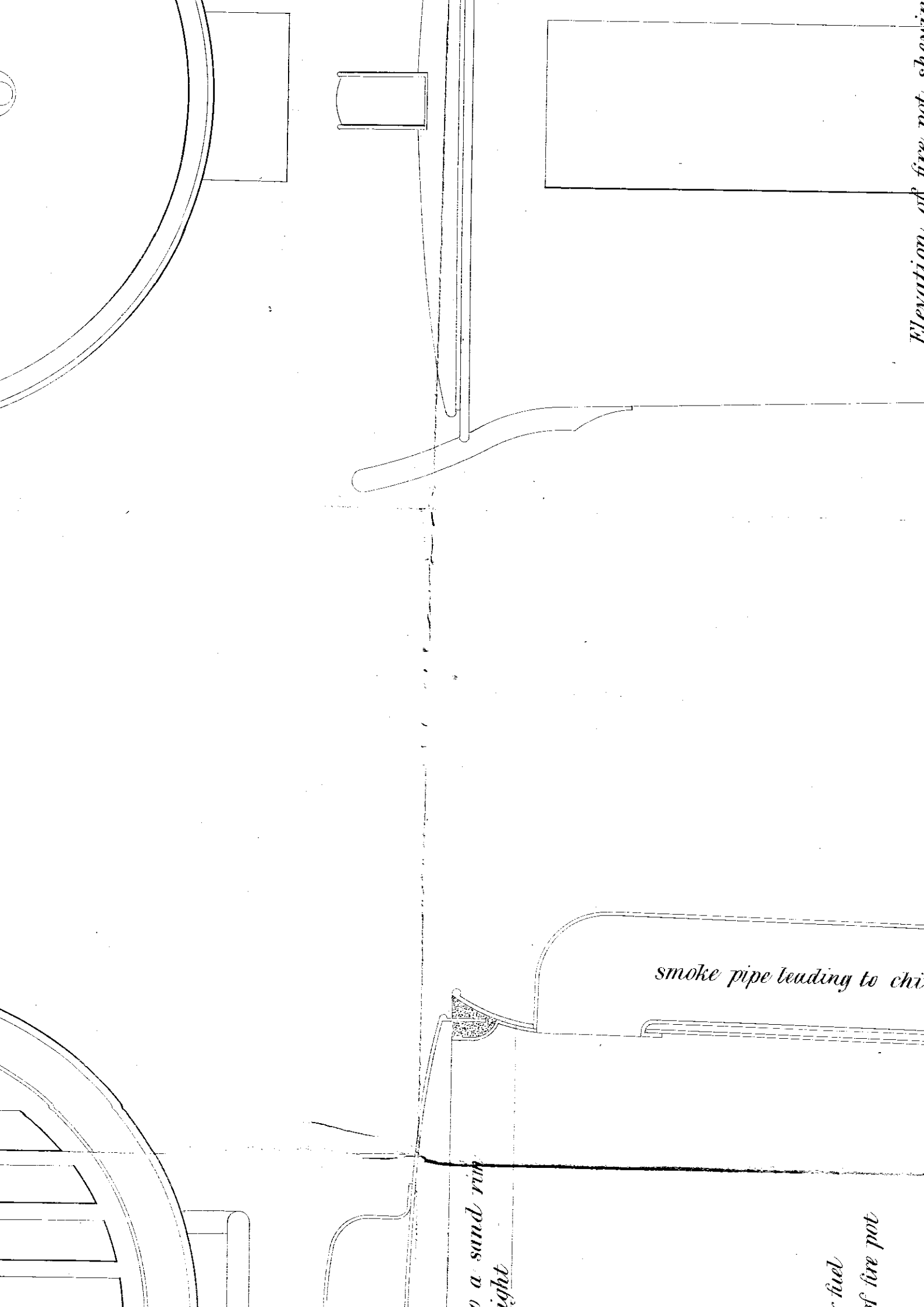

FIG. 3 Elevation





Elevation of fire pot, showing

smoke pipe leading to chi

*to a sand rim
right*

*fuel
of fire pot*

Fire Pot

sectional elevation

FIG. 4.

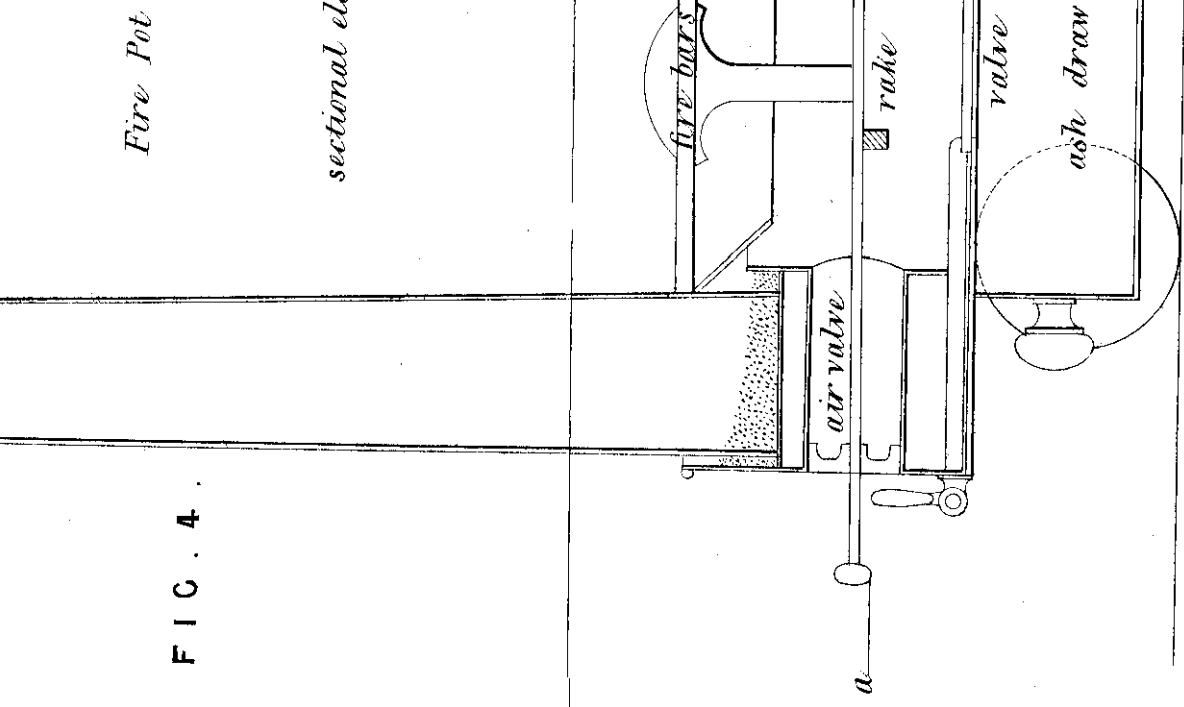
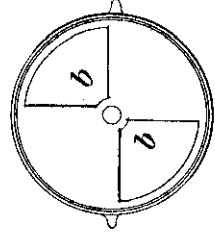
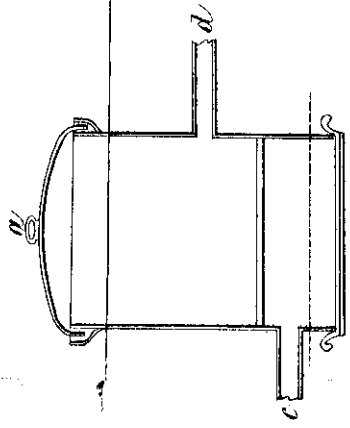
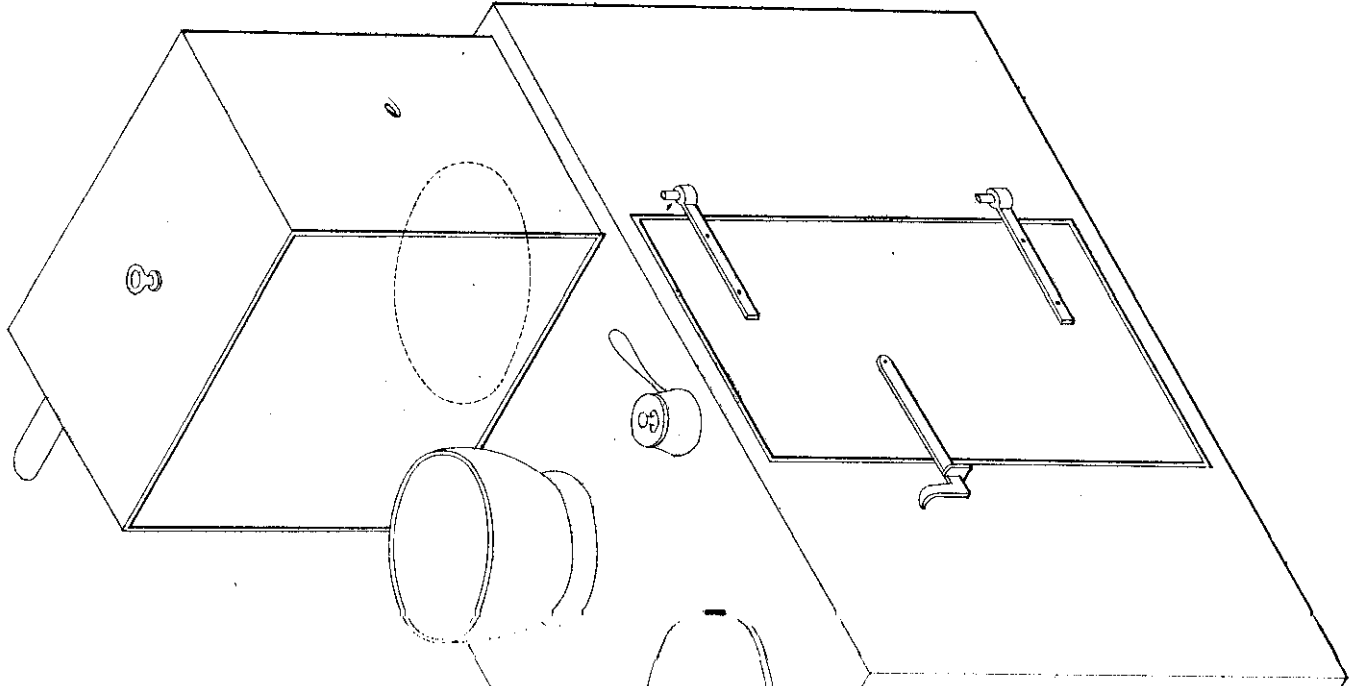
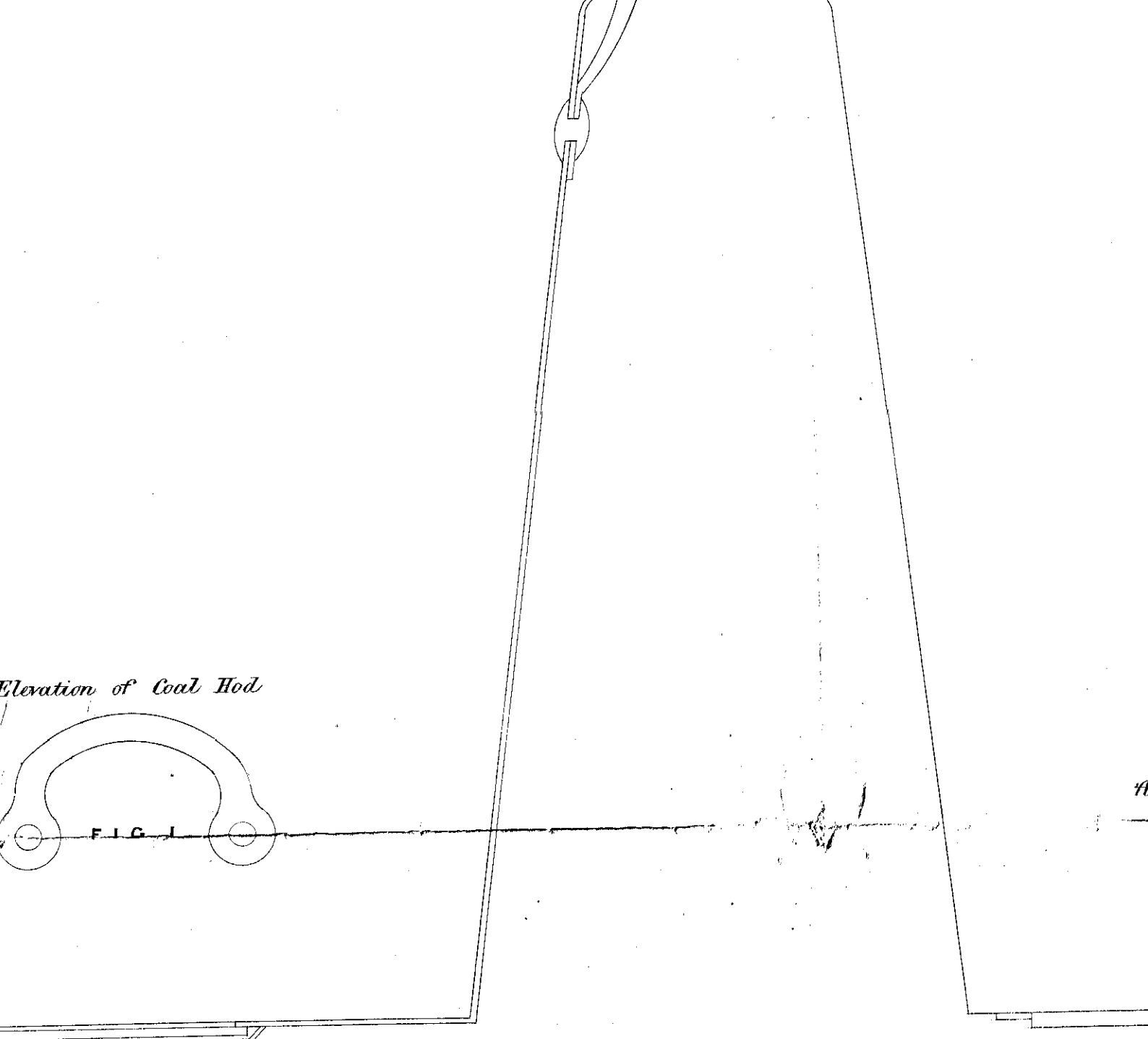

FIG. 3.
Fire pot in section



Plan of FIG. 3
through line





Elevation of Coal Hod

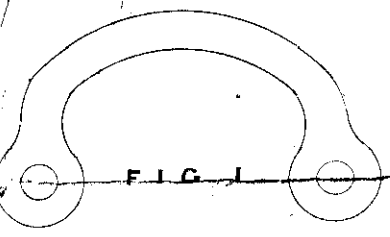
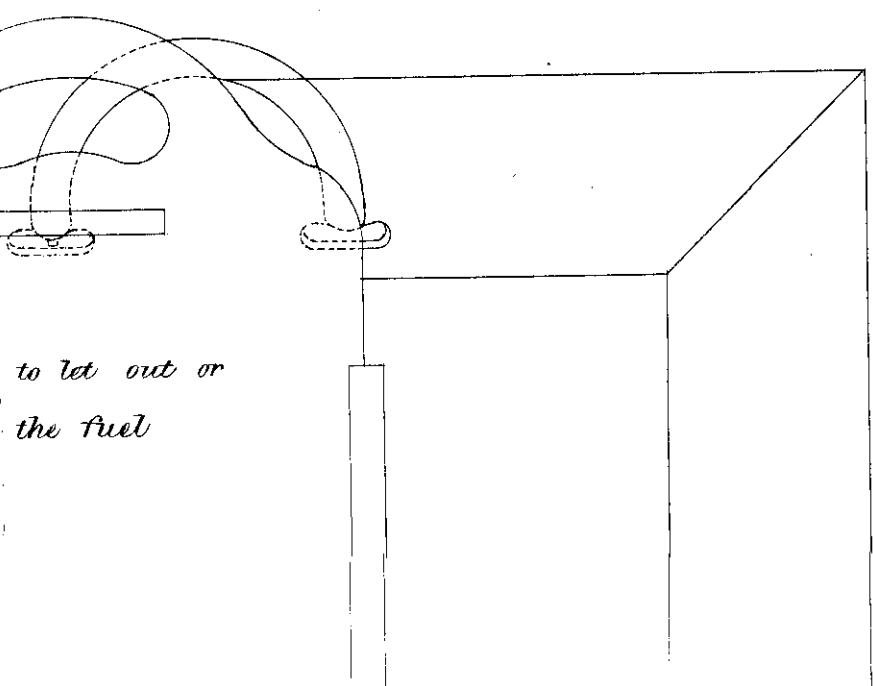
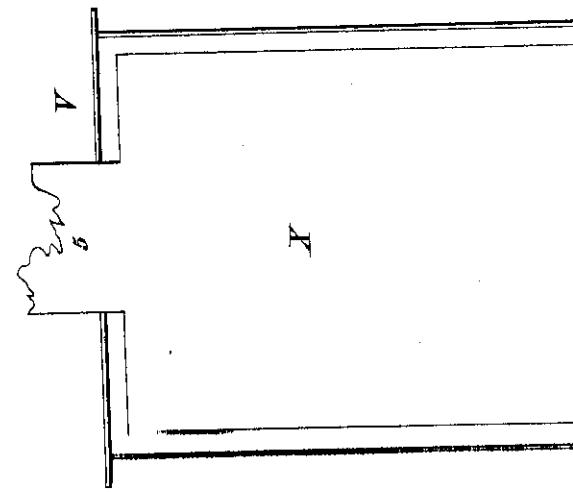
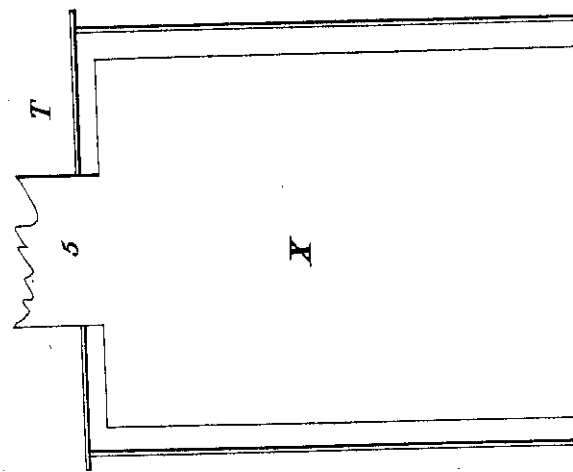
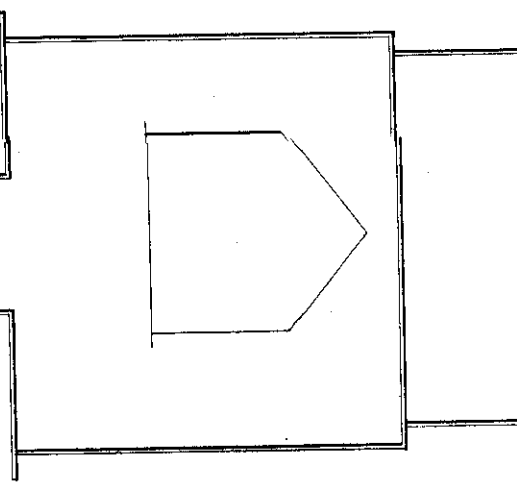
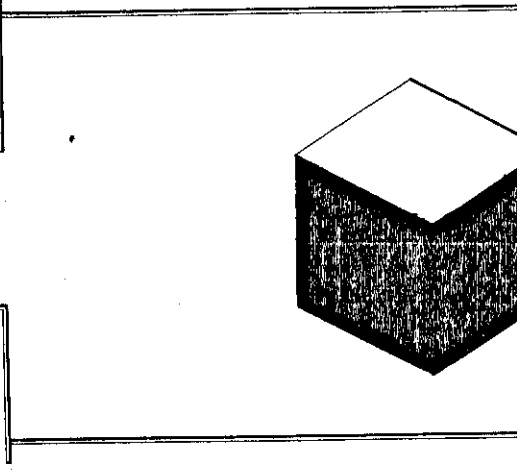
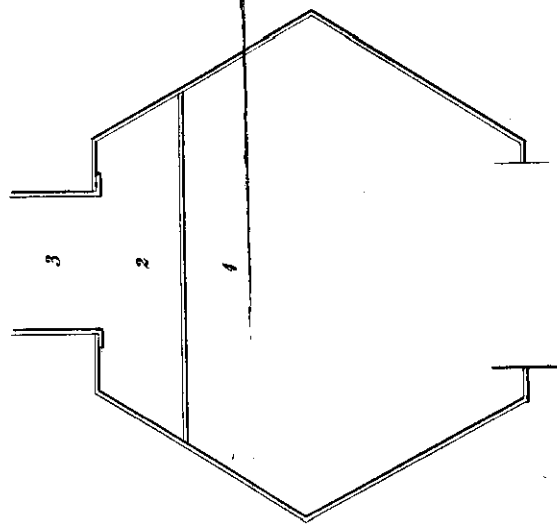
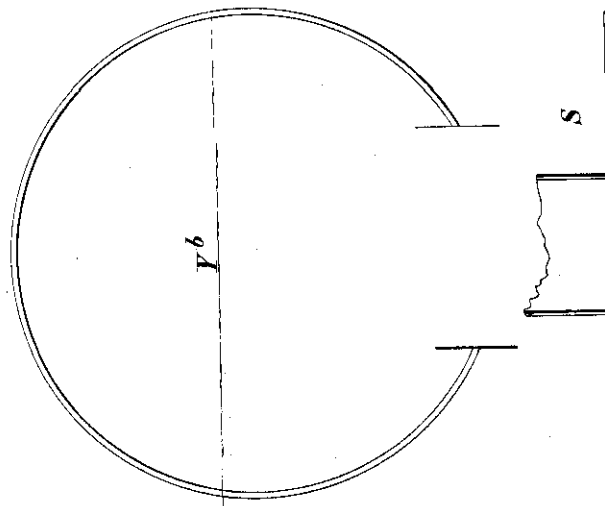
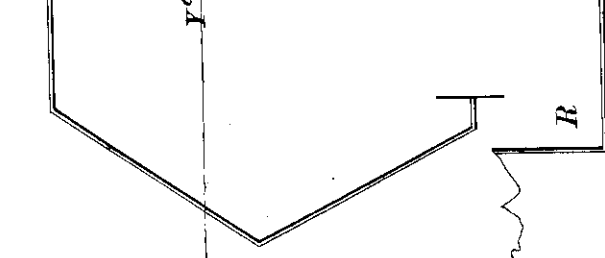
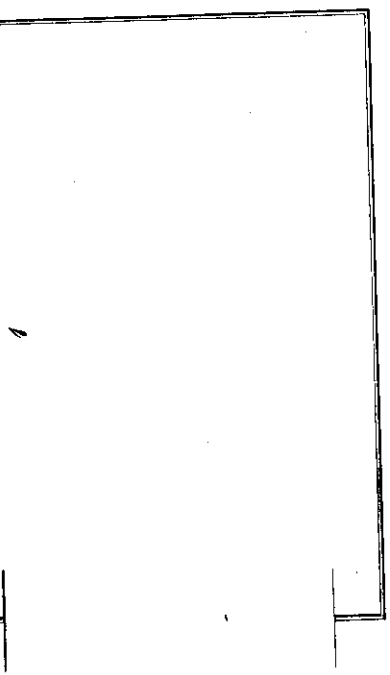
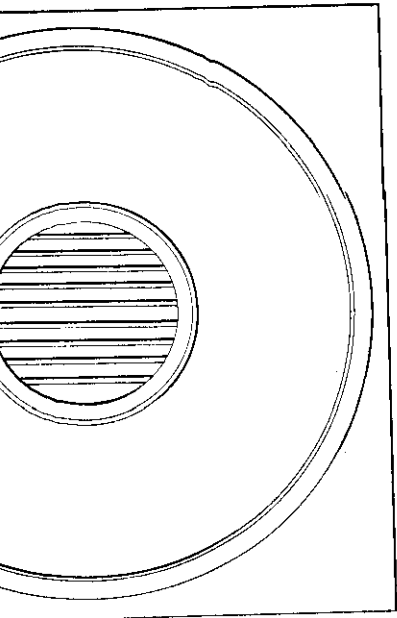
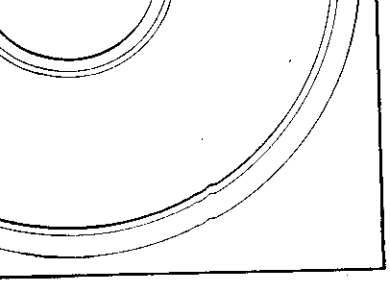

FIG. 1

let out fuel



*to let out or
the fuel*



Y

X

X